

STATE OF NORTH CAROLINA  
DEPARTMENT OF TRANSPORTATION  
HIGHWAY DIVISION 6

**PLANS**

**LETTING DATE: AUGUST 21, 2019**

**CONTRACT ID: DF00256**

**TIP NO.: R-5786FA & R-5786FB**

**FEDERAL AID NO.: TAP-0620(056) & TAP-0620(057)**

**WBS ELEMENT NO.: 44916.3.12 & 44916.3.13**

**ROUTE NO.: VARIOUS**

**LOCATION: VARIOUS**

**COUNTY: CUMBERLAND & HARNETT**

**LENGTH OF PROJECT: VARIES**

**TYPE OF WORK: CONCRETE INSTALLATIONS**

**This electronic collection of documents is provided  
for the convenience of the user  
and is Not a Certified Document –**

**The documents contained herein were originally issued  
and sealed by the individuals whose names and license  
numbers appear on each page, on the dates appearing  
with their signature on that page.**

**This file or an individual page  
shall not be considered a certified document.**

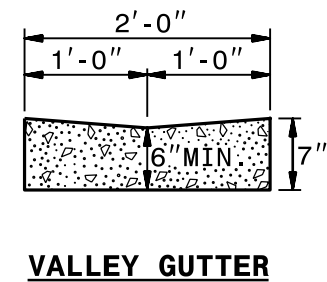
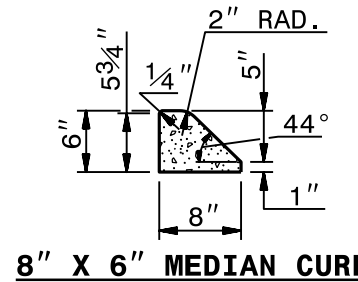
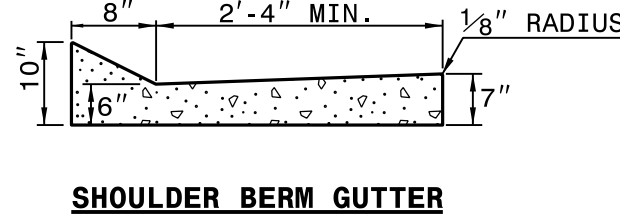
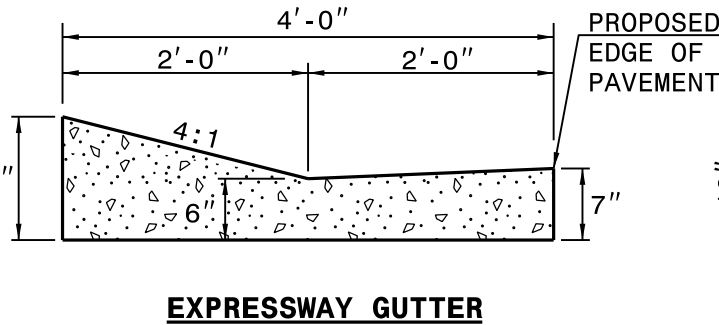
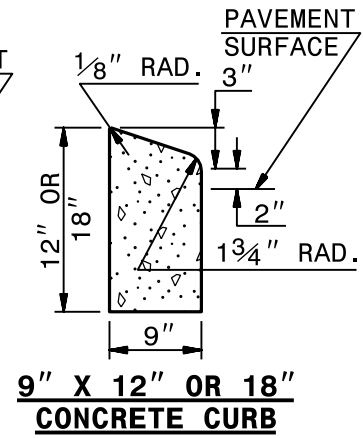
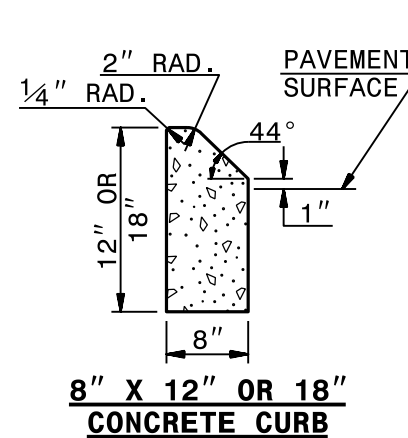
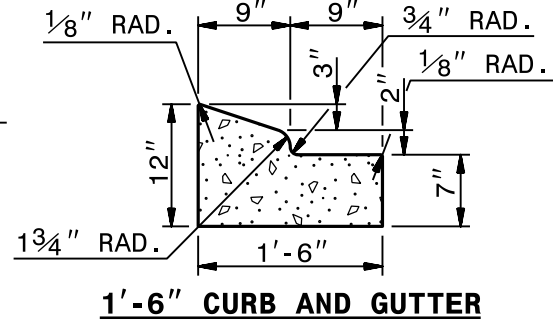
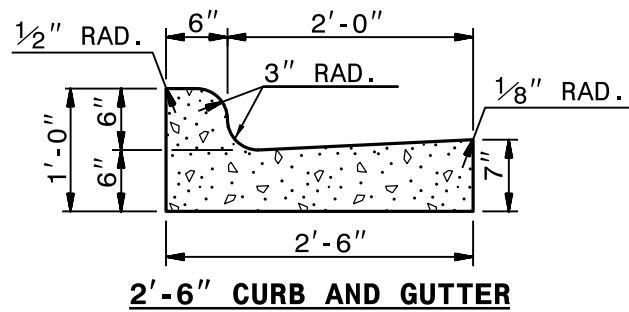

**SECTION VIEW OF CURBS OR CURBS AND GUTTERS**

**GENERAL NOTES:**

- PLACE CONTRACTION JOINTS AT 10' INTERVALS, EXCEPT THAT A 15' SPACING MAY BE USED WHEN A MACHINE IS USED OR WHEN SATISFACTORY SUPPORT FOR THE FACE FORM CAN BE OBTAINED WITHOUT THE USE OF TEMPLATES AT 10' INTERVALS.
- JOINT SPACING MAY BE ALTERED IF REQUIRED BY THE ENGINEER.
- CONTRACTION JOINTS MAY BE INSTALLED WITH THE USE OF TEMPLATES OR FORMED BY OTHER APPROVED METHODS.
- CONSTRUCT NON-TEMPLATE FORMED JOINTS A MIN. OF 1 1/2" DEEP.
- FILL ALL CONSTRUCTION JOINTS, EXCEPT IN 8"x6" MEDIAN CURB, WITH JOINT FILLER AND SEALER.
- SPACE EXPANSION JOINTS AT 90' INTERVALS AND ADJACENT TO ALL RIGID OBJECTS.

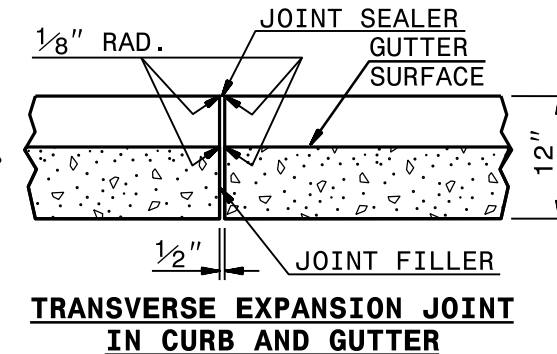
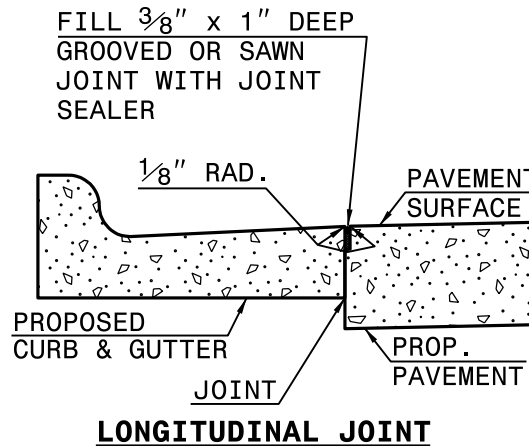

**SECTION VIEW OF JOINTS**

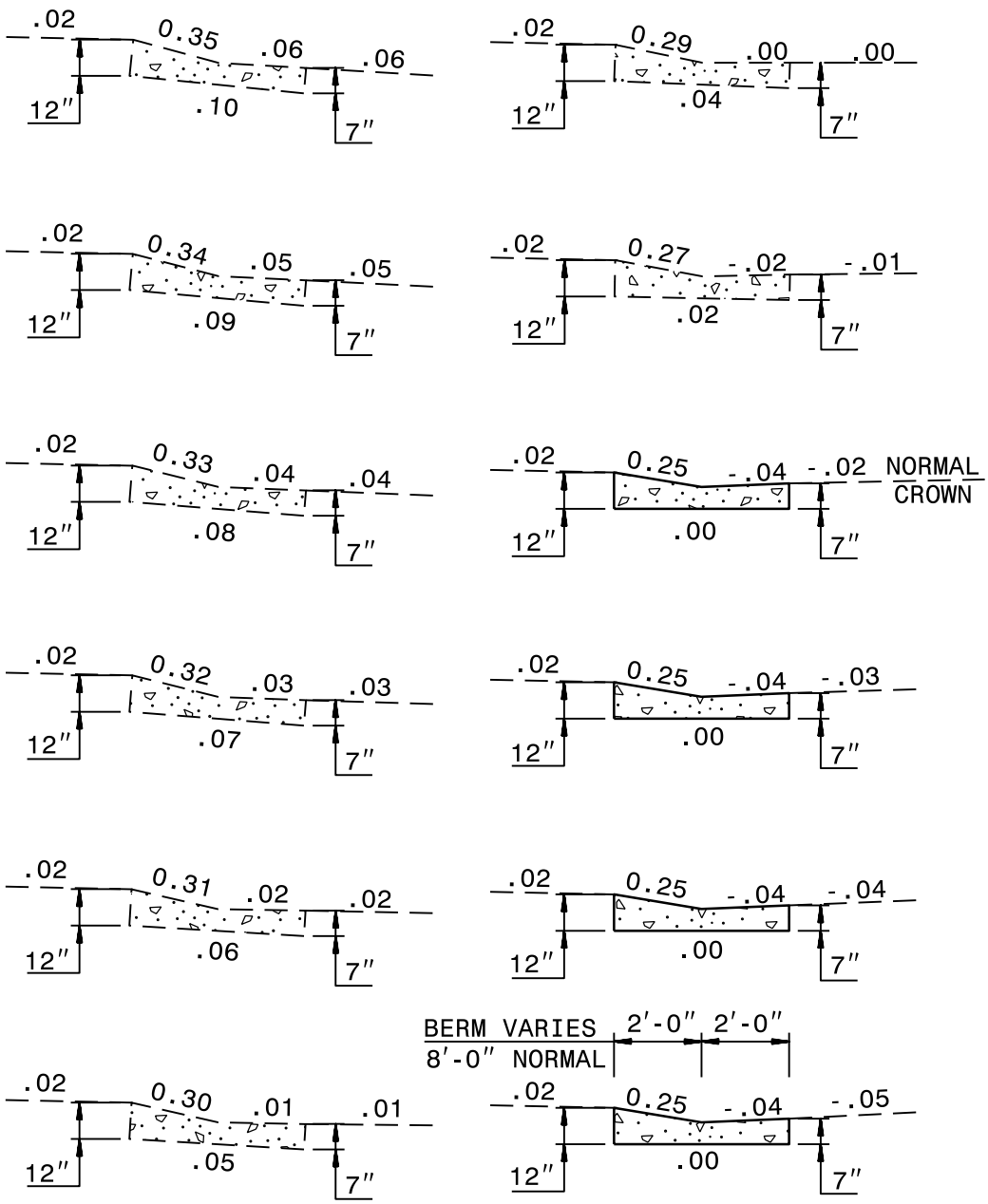

**SECTION VIEWS OF EXPRESSWAY GUTTER IN SUPER ELEVATION**

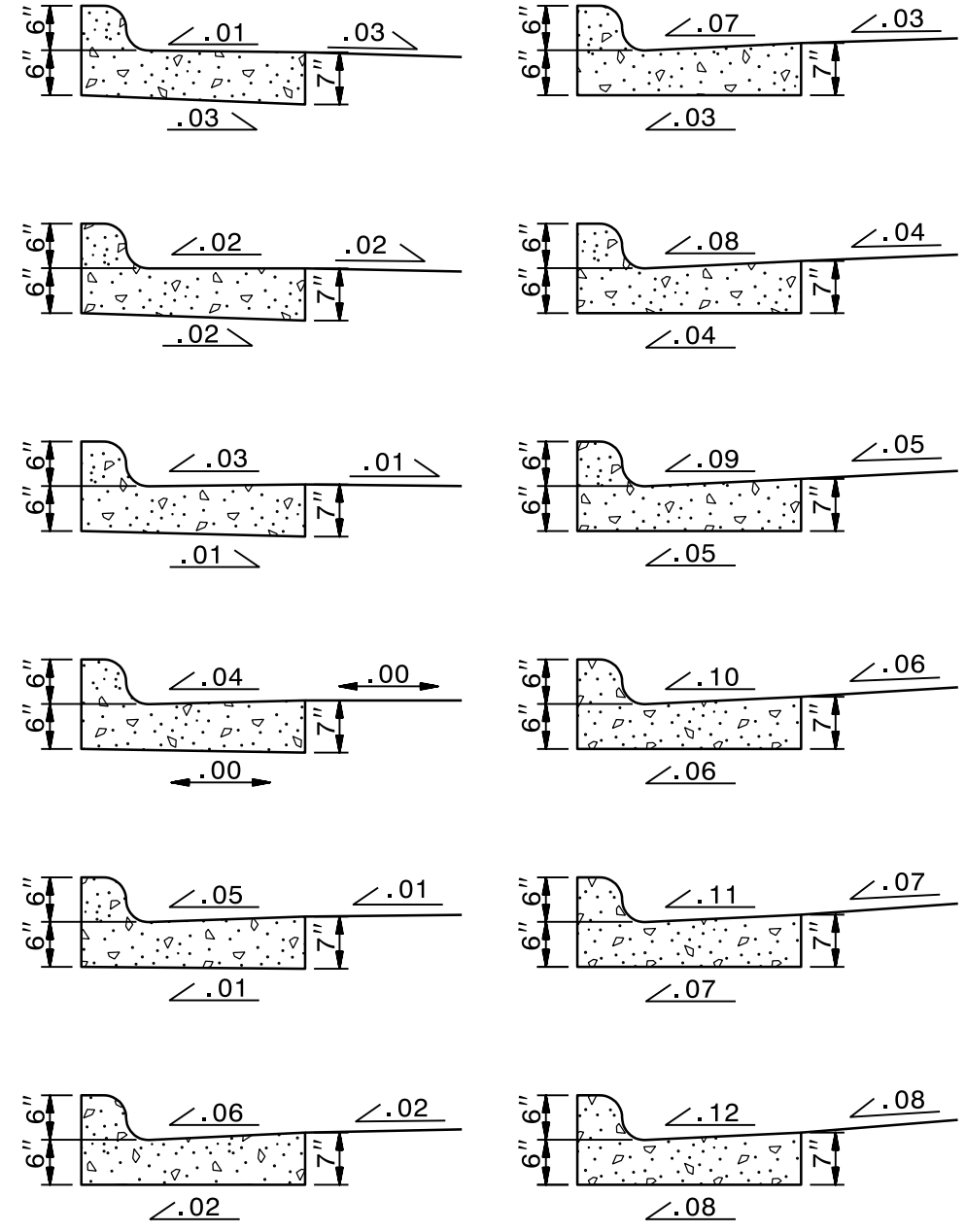

**SECTION VIEWS OF 2'-6" CURB AND GUTTER SUPERELEVATION RATES**

1-18

ROADWAY STANDARD DRAWING FOR

**CONCRETE CURB, GUTTER AND CURB & GUTTER**

STATE OF NORTH CAROLINA  
DEPT. OF TRANSPORTATION  
DIVISION OF HIGHWAYS  
RALEIGH, N.C.

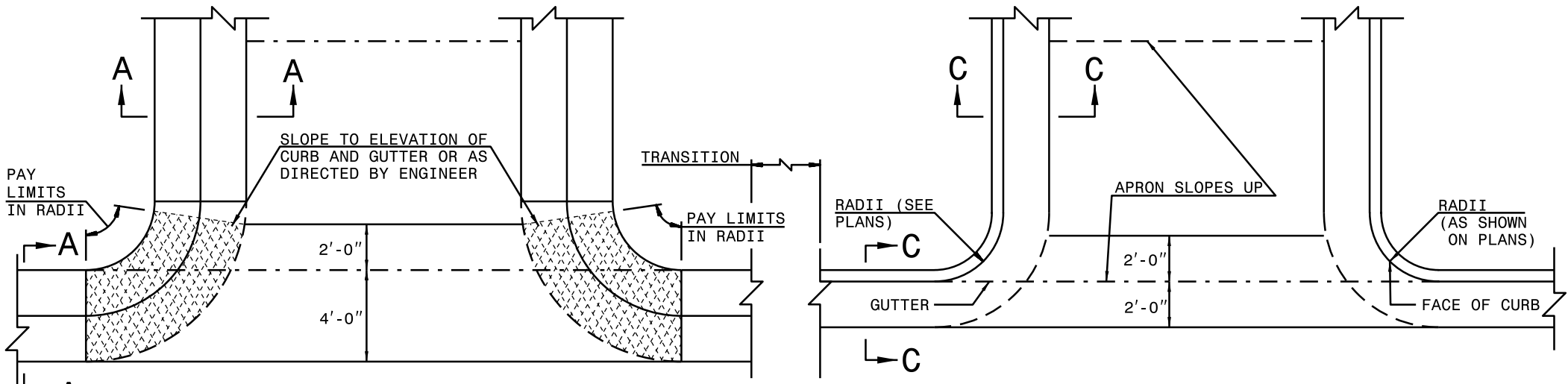

DRIVEWAY WITH EXPRESSWAY GUTTER                      TRANSITION                      DRIVEWAY WITH 2'-6" CURB AND GUTTER

**PLAN VIEW OF TYPICAL CURB AND GUTTER OCCURENCES**

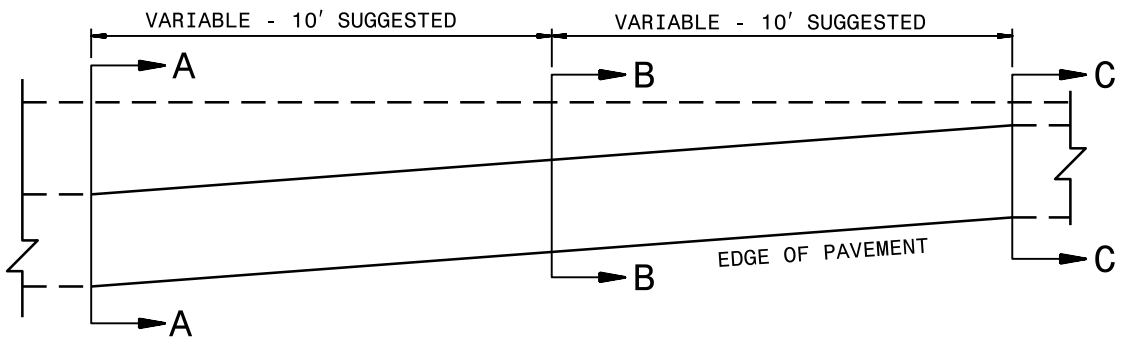

**PLAN VIEW OF TRANSITION  
EXPRESSWAY GUTTER TO 2'-6" CURB AND GUTTER**

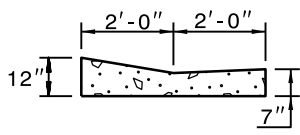

**SECTION A-A  
EXPRESSWAY GUTTER**

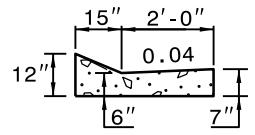

**SECTION B-B  
TRANSITION GUTTER**

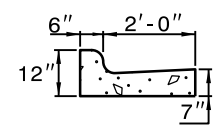

**SECTION C-C  
2'-6" CURB & GUTTER**

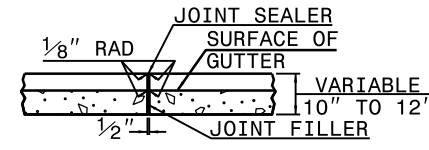

**EXPANSION JOINT**

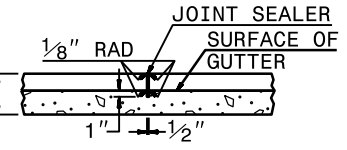

**CONTRACTION JOINT**

- NOTES:
- IN THE TRANSITION FROM 4'-0" CONCRETE EXPRESSWAY GUTTER TO 2'-6" CONCRETE CURB AND GUTTER, PLACE 1/2" EXPANSION JOINTS AT 25' INTERVALS.
  - PLACE GROOVE JOINTS 1" DEEP AT 12'-6" INTERVALS BETWEEN EXPANSION JOINTS.
  - FILL AND SEAL THE TOP 1/2" OF THE EXPANSION JOINTS AND 1" OF CONTRACTION JOINTS WITH APPROVED JOINT SEALING COMPOUND.

NOTES:

CONSTRUCT STANDARD SIDEWALK 5' WIDE AND 4" THICK UNLESS OTHERWISE DENOTED ON PLANS.

PLACE A GROOVE JOINT 1" DEEP WITH 1/8" RADII IN THE CONCRETE SIDEWALK AT 5' INTERVALS. ONE 1/2" EXPANSION JOINT WILL BE REQUIRED AT 50' INTERVALS. A 1/2" EXPANSION JOINT WILL BE REQUIRED WHERE THE SIDEWALK JOINS ANY RIGID STRUCTURE.

SEE STD. DWG. 848.05 FOR CURB RAMP LOCATION REQUIREMENTS AND CONSTRUCTION GUIDELINES.

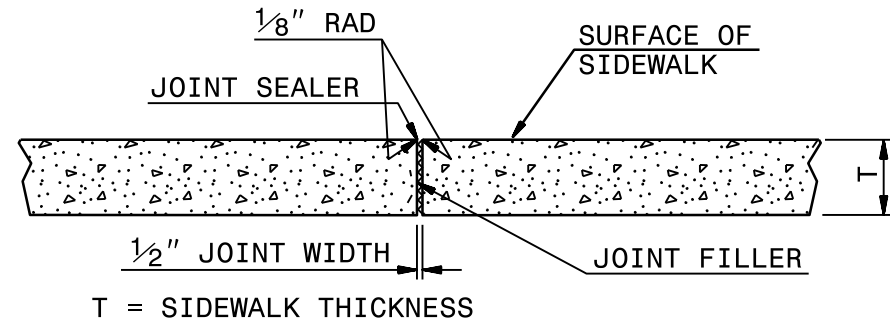

TRANSVERSE EXPANSION JOINT  
IN SIDEWALK

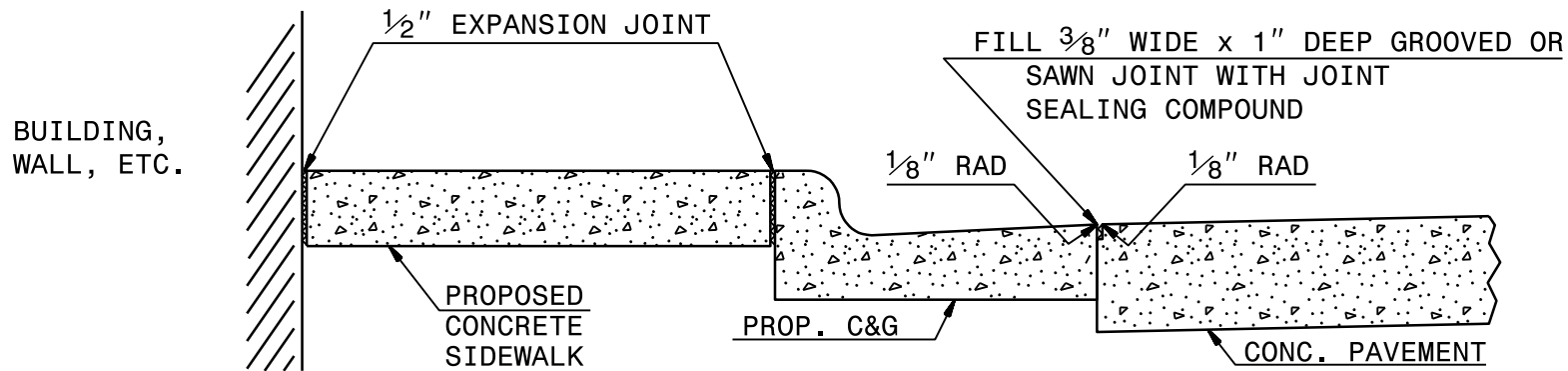

DETAILS SHOWING JOINTS IN CONCRETE SIDEWALK

STATE OF  
NORTH CAROLINA  
DEPT. OF TRANSPORTATION  
DIVISION OF HIGHWAYS  
RALEIGH, N.C.

1-18

ROADWAY STANDARD DRAWING FOR  
**CONCRETE SIDEWALK**

**CURB RAMP AND EXISTING SIDEWALK WITH GRASS STRIP**

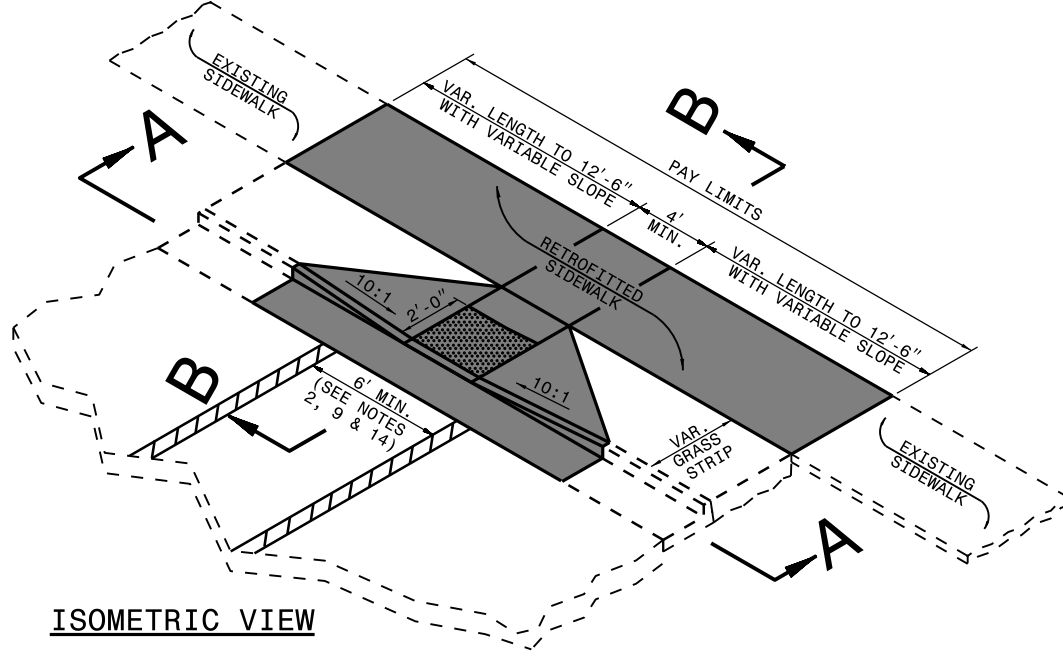

**ISOMETRIC VIEW**

**PAY LIMITS OF CURB RAMP**

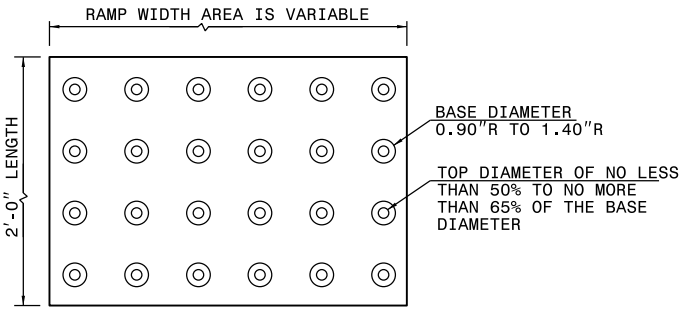

**DETECTABLE WARNING DOMES**

- NOTES:**
1. PLACE DETECTABLE WARNING DOMES TO COVER 2'-0" LENGTH AND FULL WIDTH OF THE RAMP FLOOR AS SHOWN ON THE DETAILS.
  2. OBTAIN VISIBLE CONTRAST WITH ADJOINING SURFACE, EITHER LIGHT-ON-DARK, OR DARK-ON-LIGHT SEQUENCE COVERING THE ENTIRE RAMP.

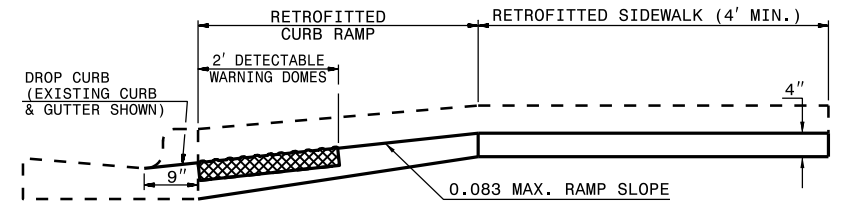

**SECTION B-B**

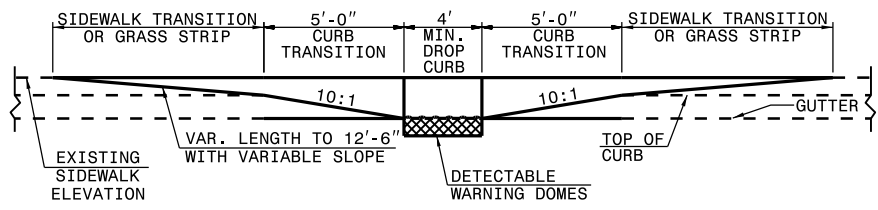

**SECTION A-A**

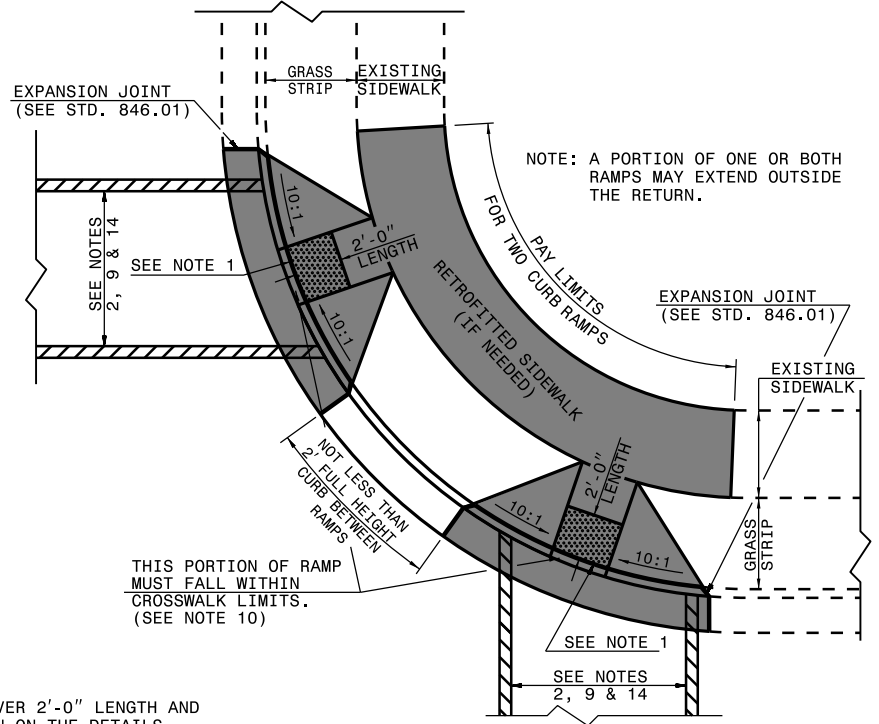

**PLAN VIEW**

DUAL RAMPS  
ANY RADII  
(40" MIN. FLOOR WIDTH)

**1-18**

ROADWAY STANDARD DRAWING FOR

**CURB RAMP**  
EXISTING CURB AND GUTTER

**CURB RAMPS AND EXISTING SIDEWALK ADJACENT TO CURB**

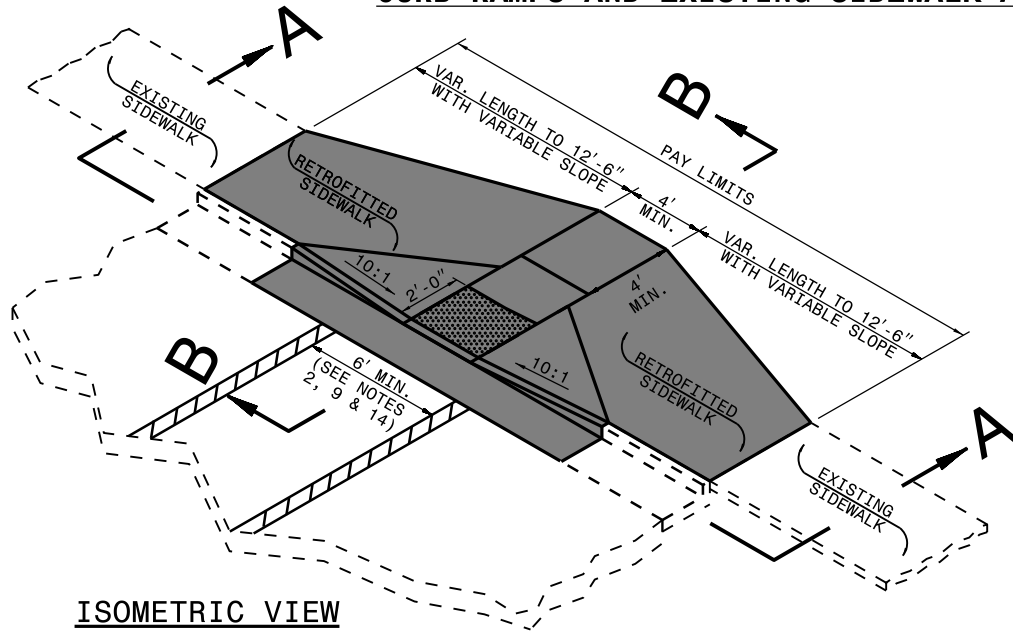

**ISOMETRIC VIEW**

PAY LIMITS OF CURB RAMP

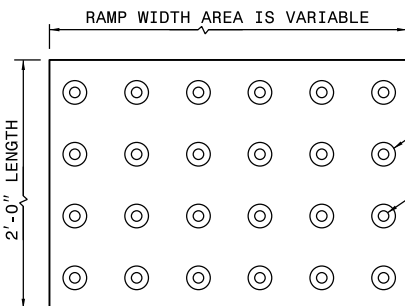

BASE DIAMETER  
0.90"R TO 1.40"R

TOP DIAMETER OF NO LESS  
THAN 50% TO NO MORE  
THAN 65% OF THE BASE  
DIAMETER

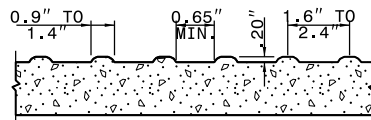

- NOTES:
1. PLACE DETECTABLE WARNING DOMES TO COVER 2'-0" LENGTH AND FULL WIDTH OF THE RAMP FLOOR AS SHOWN ON THE DETAILS.
  2. OBTAIN VISIBLE CONTRAST WITH ADJOINING SURFACE, EITHER LIGHT-ON-DARK, OR DARK-ON-LIGHT SEQUENCE COVERING THE ENTIRE RAMP.

**DETECTABLE WARNING DOMES**

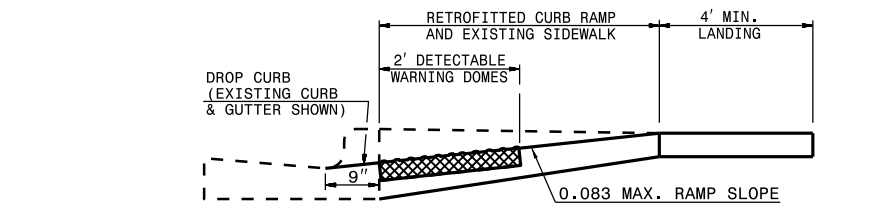

**SECTION B-B**

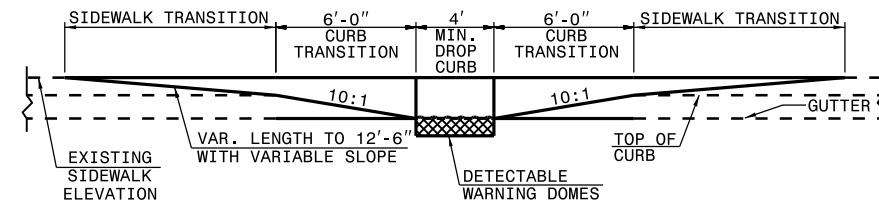

**SECTION A-A**

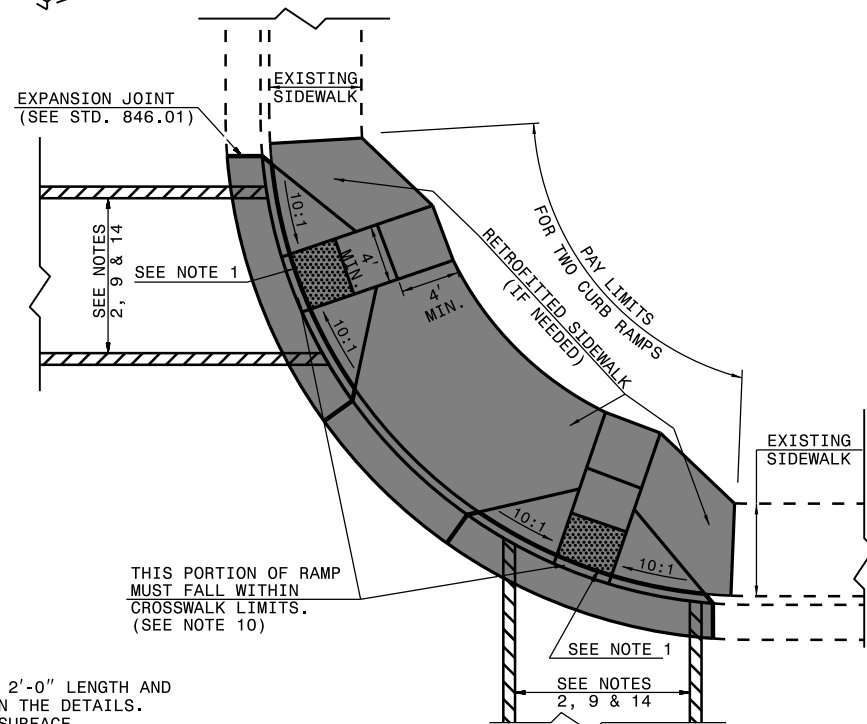

**PLAN VIEW**

DUAL RAMPS  
ANY RADII  
(40" MIN. FLOOR WIDTH)

1-18

ROADWAY STANDARD DRAWING FOR

**CURB RAMP**

EXISTING CURB AND GUTTER



**RETROFITTING DETECTABLE WARNING DOMES ONTO EXISTING CURB RAMP**

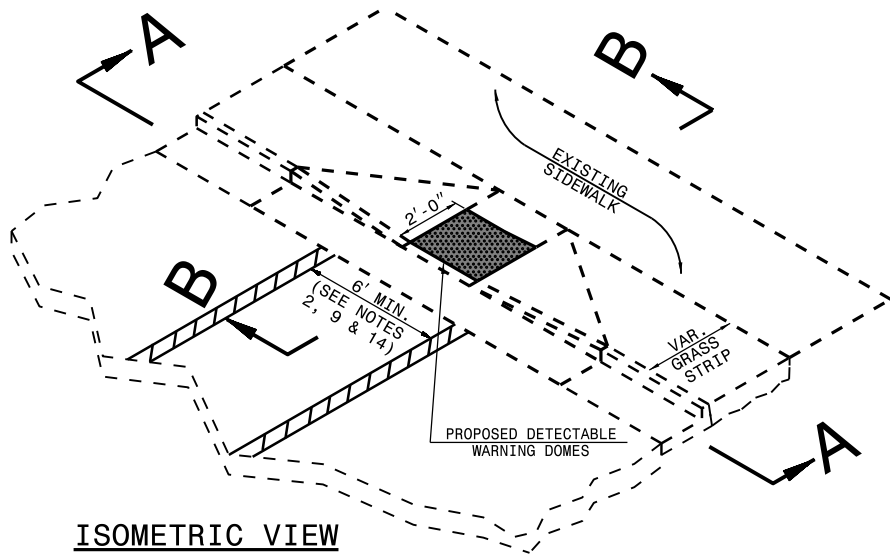

PAY LIMITS OF RETROFIT CURB RAMP

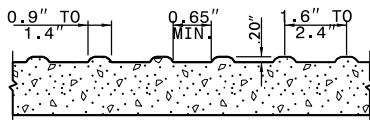
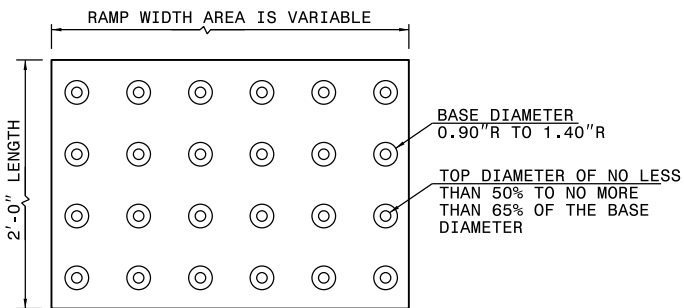

**DETECTABLE WARNING DOMES**

- NOTES:
1. PLACE DETECTABLE WARNING DOMES TO COVER 2'-0" LENGTH AND FULL WIDTH OF THE RAMP FLOOR AS SHOWN ON THE DETAILS.
  2. OBTAIN VISIBLE CONTRAST WITH ADJOINING SURFACE, EITHER LIGHT-ON-DARK, OR DARK-ON-LIGHT SEQUENCE COVERING THE ENTIRE RAMP.

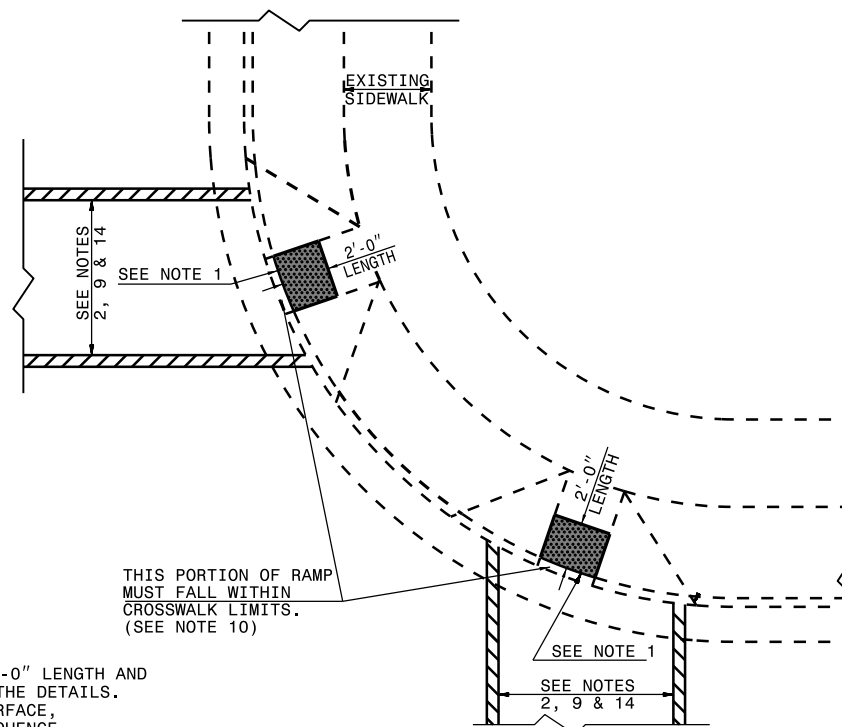
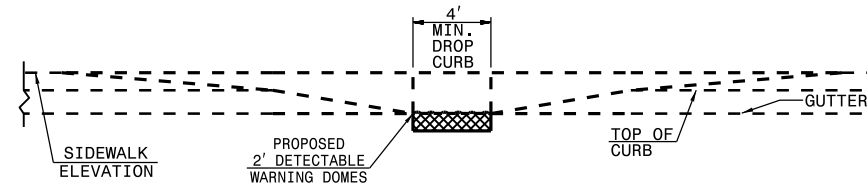
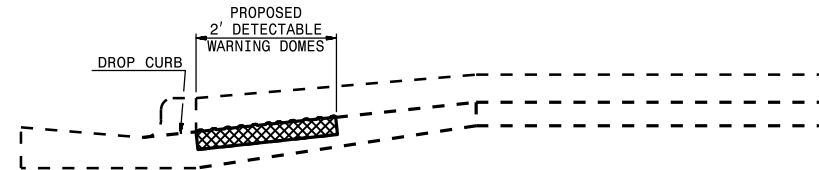

**PLAN VIEW**

DUAL RAMPS  
ANY RADII  
(40" MIN. FLOOR WIDTH)

ROADWAY STANDARD DRAWING FOR

**CURB RAMP**

EXISTING CURB AND GUTTER

1-18

STATE OF  
NORTH CAROLINA  
DEPT. OF TRANSPORTATION  
DIVISION OF HIGHWAYS  
RALEIGH, N.C.

SHEET 3 OF 5

848.06

**CURB RAMPS AND EXISTING SIDEWALK**

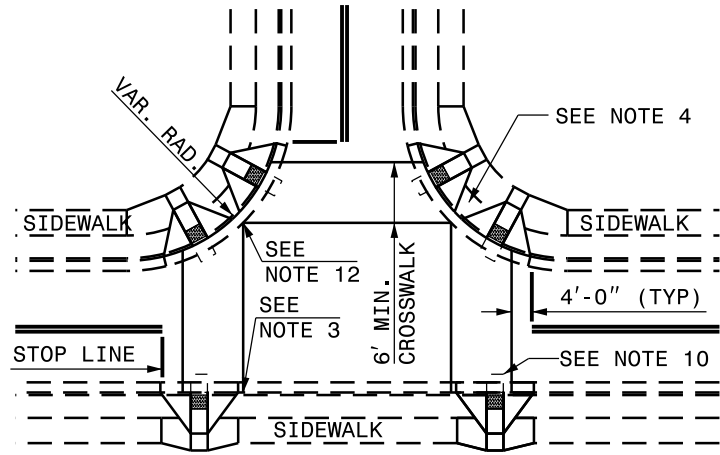

DETAIL SHOWING TYPICAL LOCATION OF CURB RAMPS, PEDESTRIAN CROSSWALKS AND STOP LINES FOR TEE INTERSECTIONS

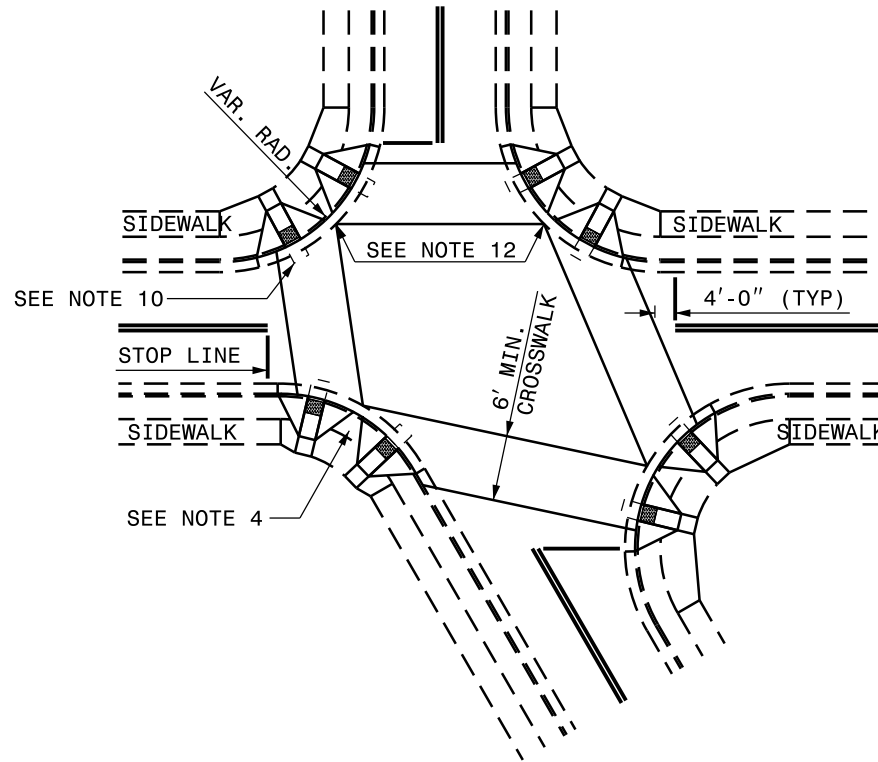

DETAIL SHOWING TYPICAL LOCATION OF CURB RAMPS, PEDESTRIAN CROSSWALKS AND STOP LINES

**RESURFACING PROJECTS**

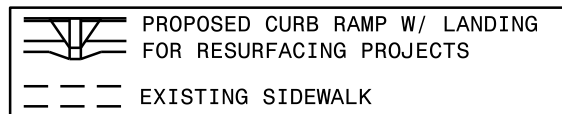

ALLOWABLE LOCATIONS  
 DUAL RAMP RADII.....ANY

## CURB RAMP AND EXISTING SIDEWALK

### NOTES:

1. CONSTRUCT THE RAMP SURFACE TO BE STABLE, FIRM, AND SLIP RESISTANT. CONSTRUCT THE CURB RAMP TYPE AS SHOWN IN THE PAVEMENT MARKING PLANS OR AS DIRECTED BY THE ENGINEER.
2. LOCATE CURB RAMPS AND PLACE PEDESTRIAN CROSSWALK MARKINGS AS SHOWN IN THE PAVEMENT MARKING PLANS. WHEN FIELD ADJUSTMENTS REQUIRE MOVING CURB RAMPS OR MARKINGS AS SHOWN, CONTACT THE SIGNING AND DELINEATION UNIT OR LOCATE AS DIRECTED BY THE ENGINEER.
3. COORDINATE THE CURB RAMP AND THE PEDESTRIAN CROSSWALK MARKINGS SO A 4'x4' CLEAR SPACE AT THE BASE OF THE CURB RAMP WILL FALL WITHIN THE PEDESTRIAN CROSSWALK LINES.
4. SET BACK DISTANCE FROM INSIDE CROSSWALK MARKING TO NEAREST EDGE OF TRAVEL LANE IS 4' MINIMUM.
5. REFER TO THE PAVEMENT MARKING PLANS FOR STOP BAR LOCATIONS AT SIGNALIZED INTERSECTIONS. IF A PAVEMENT MARKING PLAN IS NOT PROVIDED, CONTACT THE SIGNAL DESIGN SECTION FOR THE STOP BAR LOCATIONS OR LOCATE AS DIRECTED BY THE ENGINEER.
6. TERMINATE PARKING A MINIMUM OF 20' BACK OF A PEDESTRIAN CROSSWALK.
7. CONSTRUCT CURB RAMPS A MINIMUM OF 4' WIDE.
8. CONSTRUCT THE RUNNING SLOPE OF THE RAMP 8.33% MAXIMUM.
9. ALLOWABLE CROSS SLOPE ON SIDEWALKS AND CURB RAMPS WILL BE 2% MAXIMUM.
10. CONSTRUCT THE SIDE FLARE SLOPE A MAXIMUM OF 10% MEASURED ALONG THE CURB LINE.
11. CONSTRUCT THE COUNTER SLOPE OF THE GUTTER OR STREET AT THE BASE OF THE CURB RAMP A MAXIMUM OF 5% AND MAINTAIN A SMOOTH TRANSITION.
12. CONSTRUCT LANDINGS FOR SIDEWALK A MINIMUM OF 4'x4' WITH A MAXIMUM SLOPE OF 2% IN ANY DIRECTION. CONSTRUCT LANDINGS FOR MEDIAN ISLANDS A MINIMUM OF 5'x5' WITH A MAXIMUM SLOPE OF 2% IN ANY DIRECTION.
13. TO USE A MEDIAN ISLAND AS A PEDESTRIAN REFUGE AREA, MEDIAN ISLANDS WILL BE A MINIMUM OF 6' WIDE. CONSTRUCT MEDIAN ISLANDS TO PROVIDE PASSAGE OVER OR THROUGH THE ISLAND.
14. SMALL CHANNELIZATION ISLANDS THAT CAN NOT PROVIDE A 5'x5' LANDING AT THE TOP OF A RAMPS, WILL BE CUT THROUGH LEVEL WITH THE SURFACE STREET.
15. CURB RAMPS WITH RETURNED CURBS MAY BE USED ONLY WHERE PEDESTRIANS WOULD NOT NORMALLY WALK ACROSS THE RAMP. THE ADJACENT SURFACE IS PLANTING OR OTHER NON-WALKING SURFACE OR THE SIDE APPROACH IS SUBSTANTIALLY OBSTRUCTED.
16. PLACE A 1/2" EXPANSION JOINT WHERE THE CONCRETE CURB RAMP JOINS THE CURB AS SHOWN IN ROADWAY STANDARD DRAWING 848.01
17. PLACE ALL PEDESTRIAN PUSH BUTTON ACTUATORS AND CROSSING SIGNALS AS SHOWN IN THE PLANS OR AS SHOWN IN THE MUTCD.
18. CURB RAMPS THROUGH MEDIAN ISLANDS, SINGLE RAMPS AT DUAL CROSSWALKS OR LIMITED R/W SITUATIONS, WILL BE HANDLED BY SPECIAL DETAILS. CONTACT THE CONTRACT STANDARDS AND DEVELOPMENT UNIT FOR THE DETAILS OR FOR A SPECIAL DESIGN.

1-18

ROADWAY STANDARD DRAWING FOR

**CURB RAMP**

EXISTING CURB AND GUTTER

STATE OF

NORTH CAROLINA

DEPT. OF TRANSPORTATION  
DIVISION OF HIGHWAYS

RALEIGH, N.C.

5/14/99

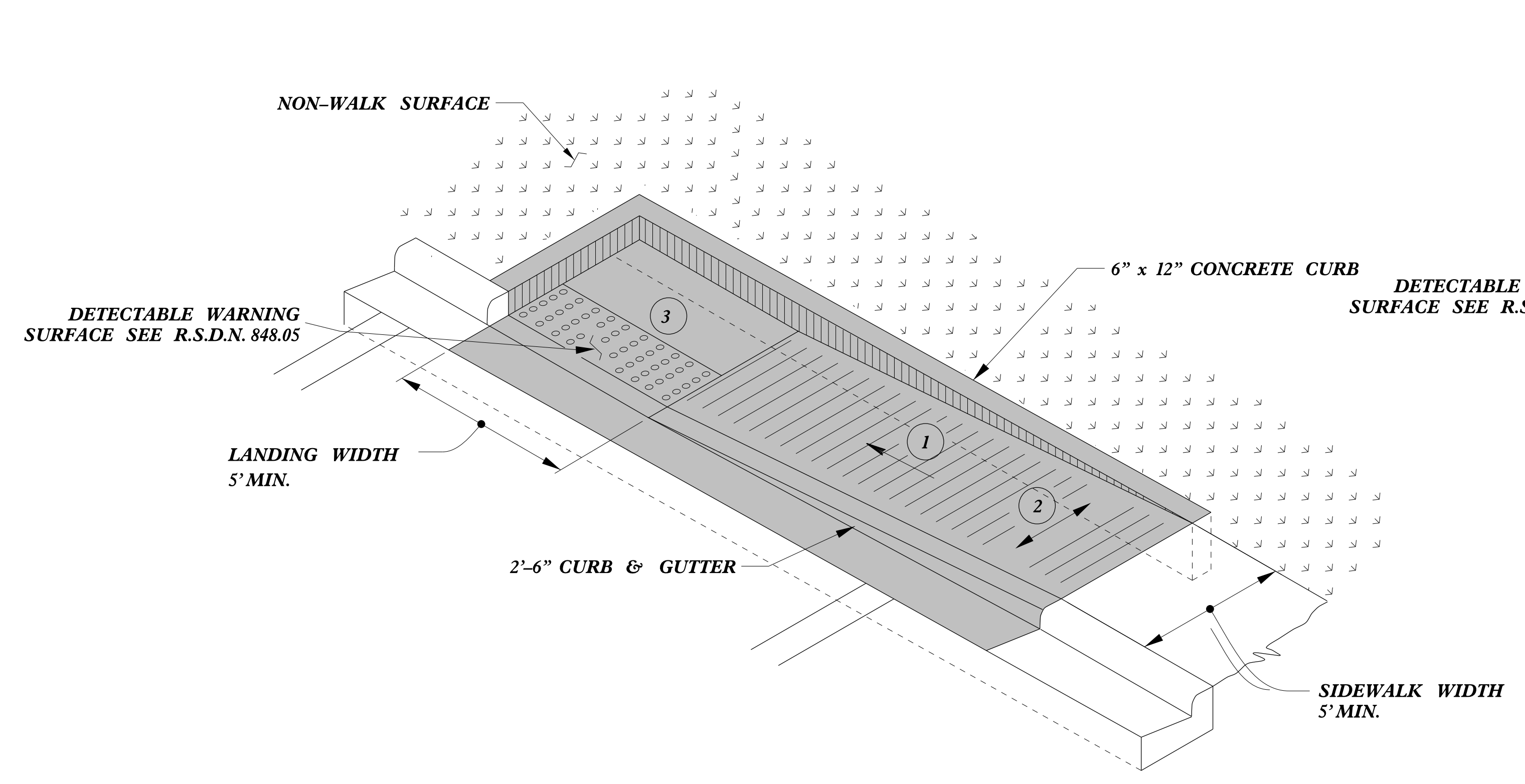

**TYPE 1A**

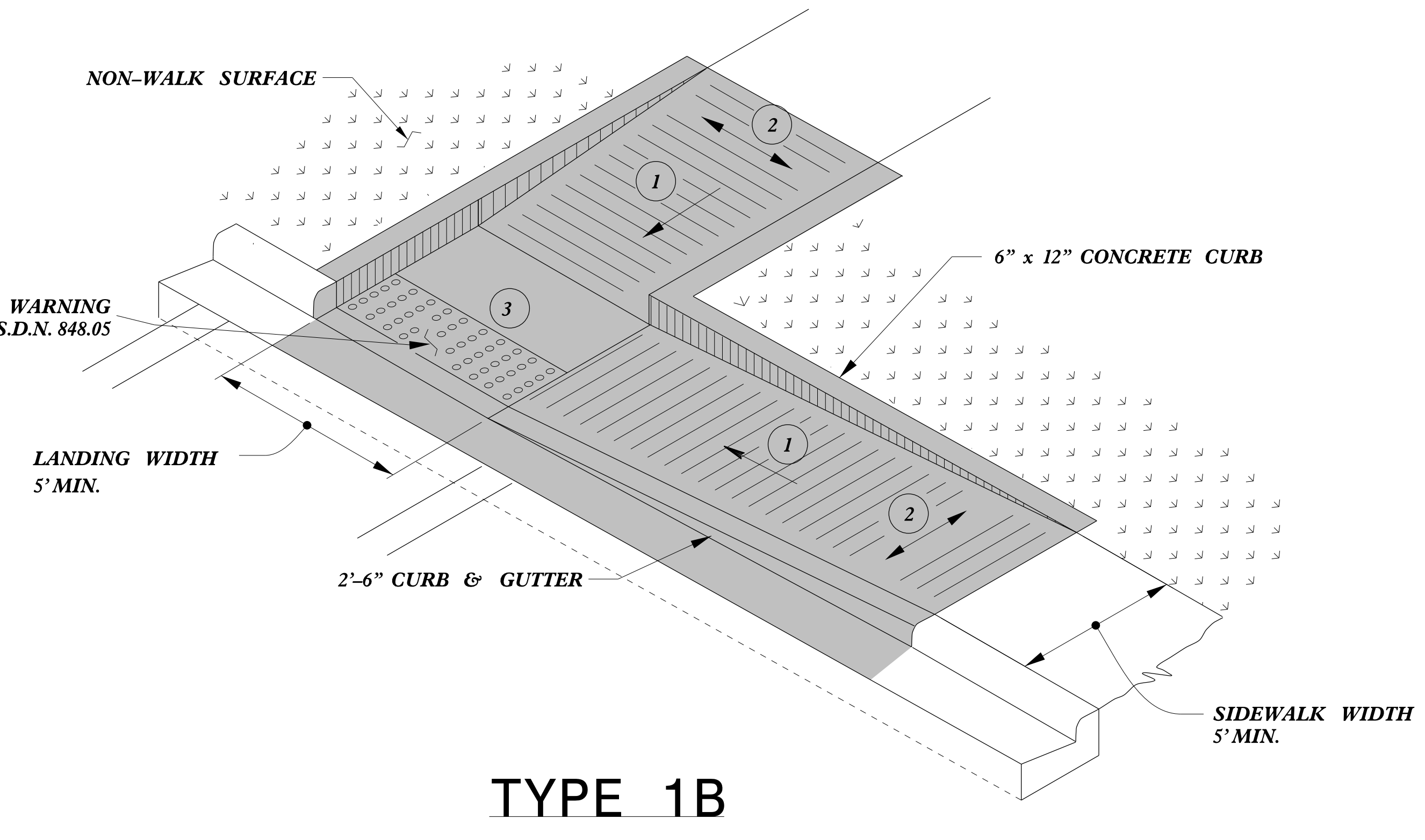

**TYPE 1B**

**PAY LIMITS FOR 1 CURB RAMP**

- 1 8.33% (12:1) MAX RAMP SLOPE
- 2 CROSS SLOPE: 2.00%
- 3 CURB RAMPS REQUIRE A (4'-0") MINIMUM LANDING WITH A MAXIMUM CROSS SLOPE AND LONGITUDINAL SLOPE OF 2.00% WHERE PEDESTRIANS PERFORM TURNING MANEUVERS. SLOPE TO DRAIN TO CURB.

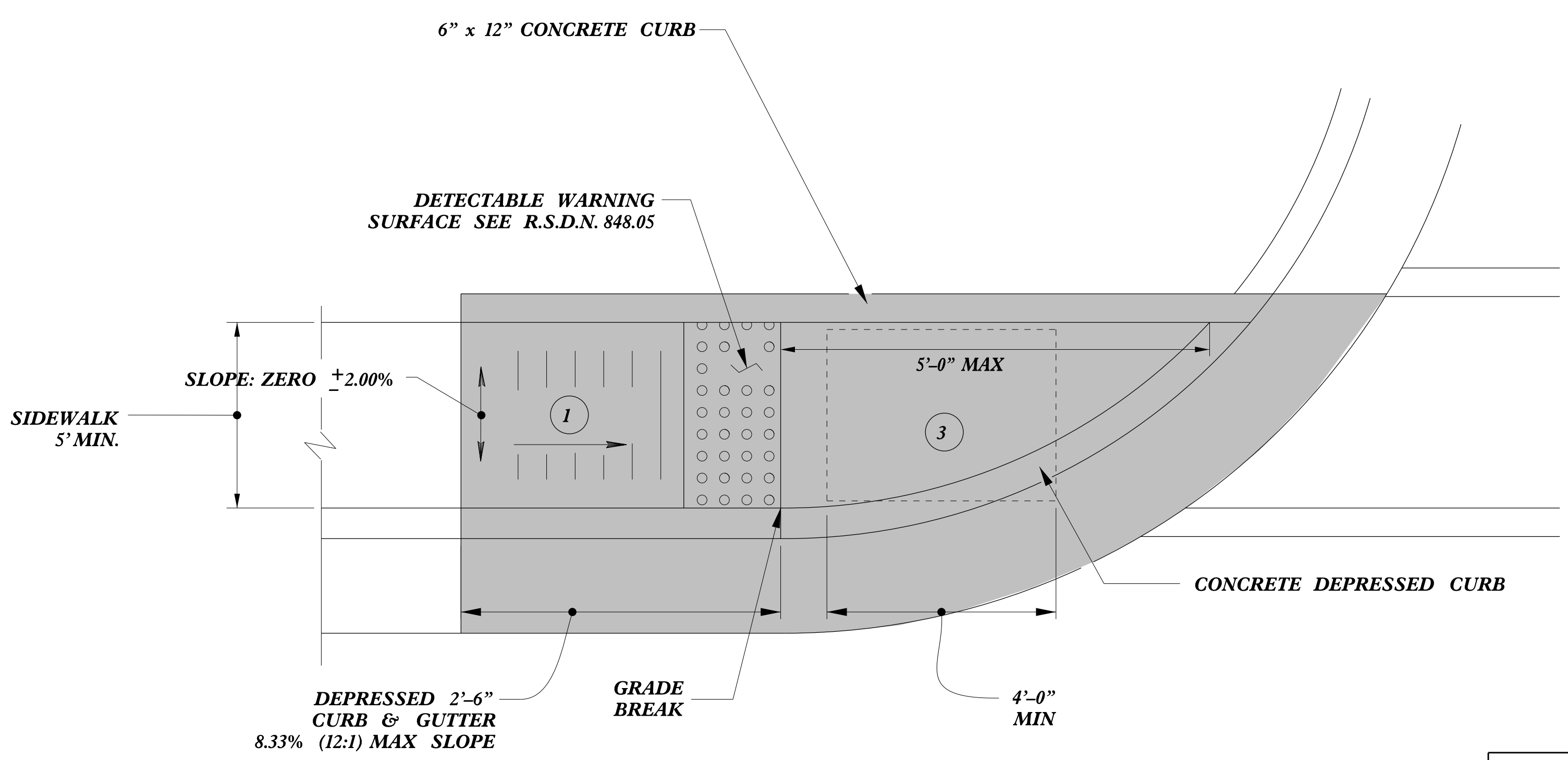

**TYPE 1**



DOCUMENT NOT CONSIDERED FINAL UNLESS ALL SIGNATURES COMPLETED

<b>CONTRACT STANDARDS AND DEVELOPMENT UNIT</b>	
Office 919-707-6950	FAX 919-250-4119
<b>CURB RAMPS</b>	
Directional Ramps	
ORIGINAL BY: J.S. HOWERTON	DATE: 7/7/11
MODIFIED BY:	DATE:
CHECKED BY:	DATE:
FILE SPEC: stds/2012CurbRamp/CurbRampDetails.dgn	

REFER TO ROADWAY STANDARD DRAWING NUMBER 848.05 SHEET 3 OF 3 FOR ALL RAMP NOTES

C:\P\2011\20110514\20110514.dwg  
 USER: JSH  
 DATE: 5/14/11  
 TIME: 10:00 AM

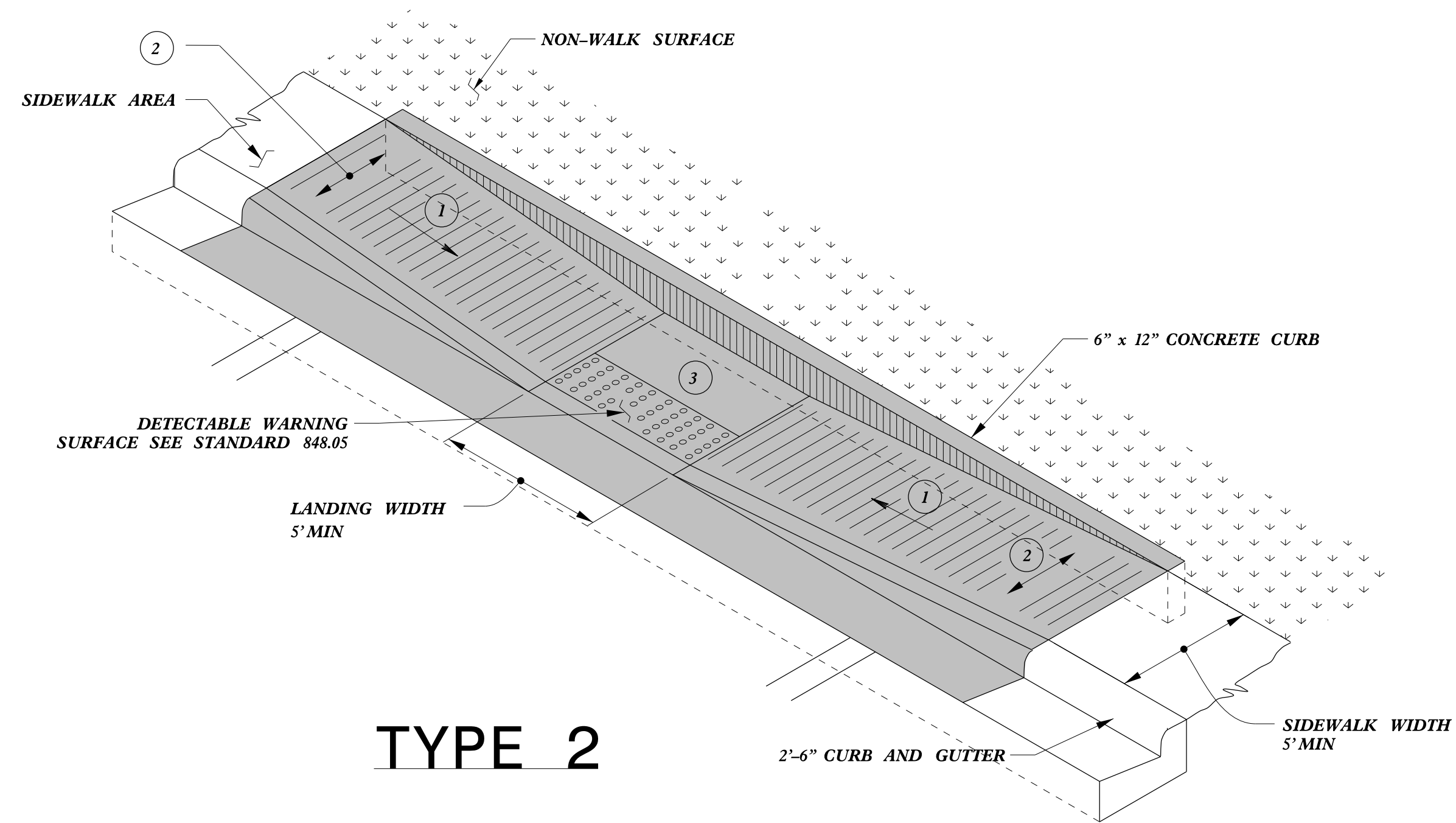

**TYPE 2**

**PAY LIMITS FOR 1 CURB RAMP**

- 1 8.33% (12:1) MAX RAMP SLOPE
- 2 CROSS SLOPE: 2.00%
- 3 CURB RAMPS REQUIRE A (4'-0") MINIMUM LANDING WITH A MAXIMUM CROSS SLOPE AND LONGITUDINAL SLOPE OF 2.00% WHERE PEDESTRIANS PERFORM TURNING MANEUVERS. SLOPE TO DRAIN TO CURB.

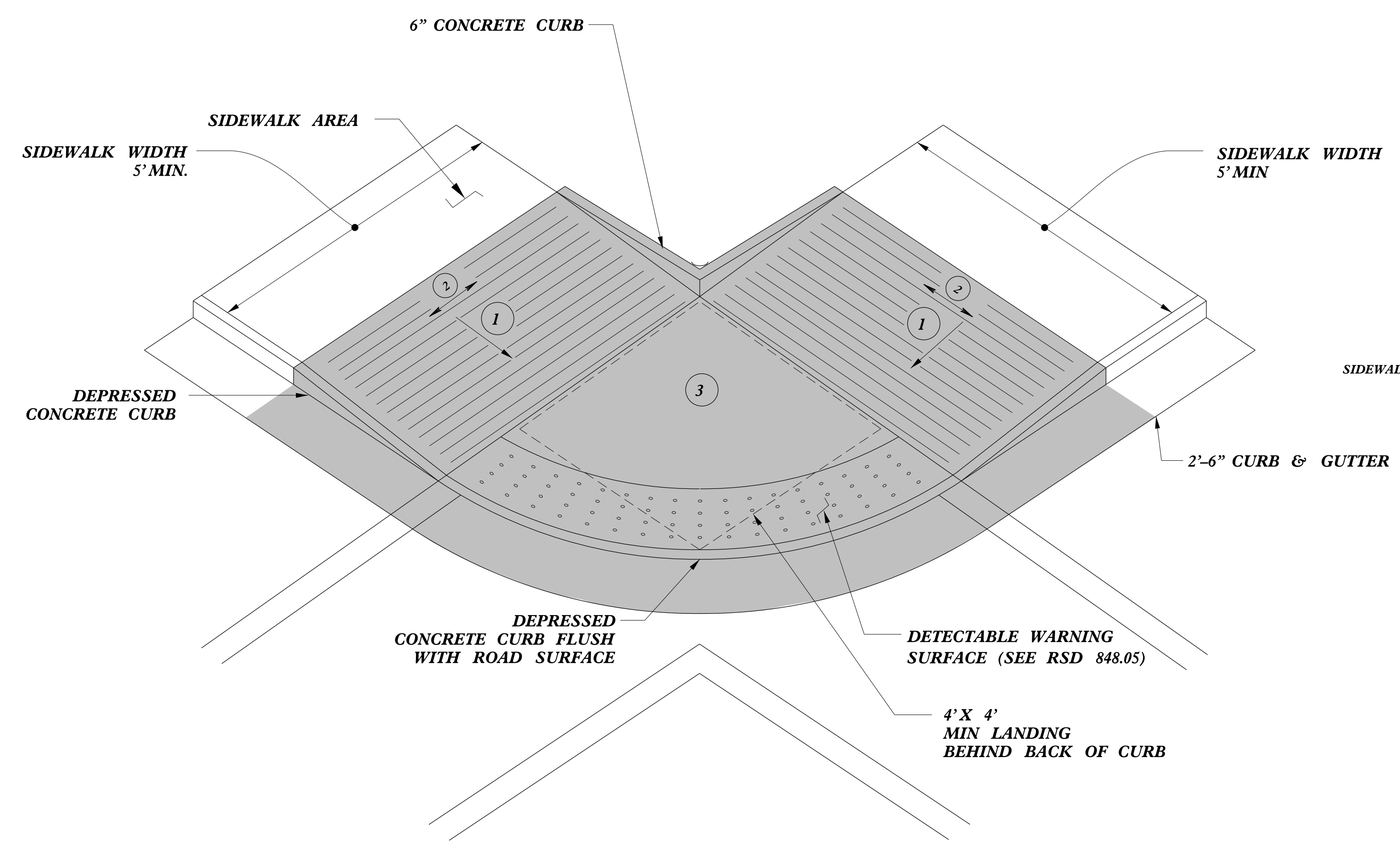

**TYPE 2A**

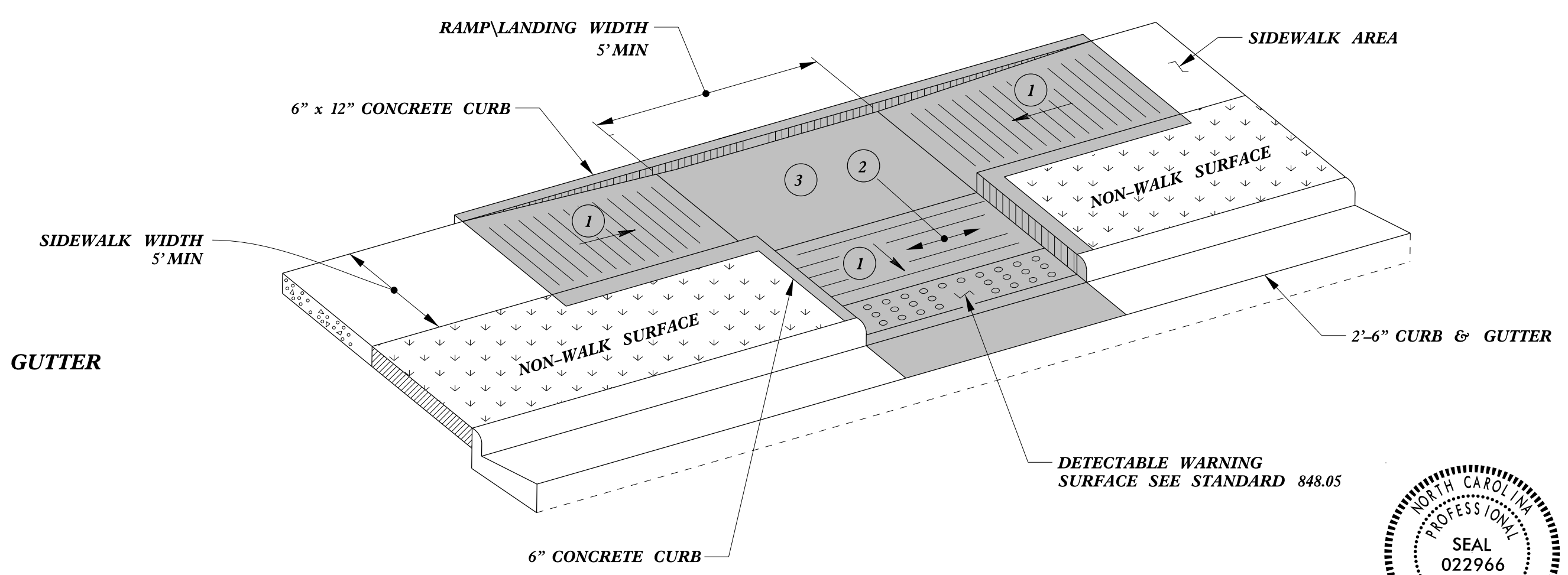

**TYPE 3**

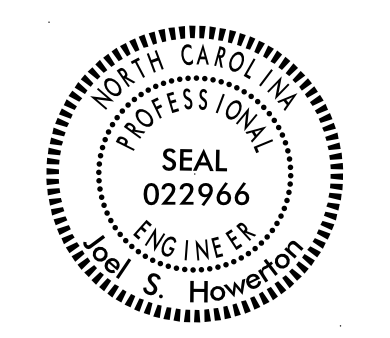

DOCUMENT NOT CONSIDERED FINAL UNLESS ALL SIGNATURES COMPLETED

<b>CONTRACT STANDARDS AND DEVELOPMENT UNIT</b>	
Office 919-707-6950	FAX 919-250-4119
<b>CURB RAMPS</b>	
Parallel Ramps	
ORIGINAL BY: J.S. HOWERTON	DATE: 7/7/11
MODIFIED BY:	DATE:
CHECKED BY:	DATE:
FILE SPEC. :stds/2012CurbRamp/CurbRampDetails.dgn	

REFER TO ROADWAY STANDARD DRAWING NUMBER 848.05 SHEET 3 OF 3 FOR ALL RAMP NOTES

5/14/99  
C:\ME\DWG\CON\CON\USER\NAME.DWG

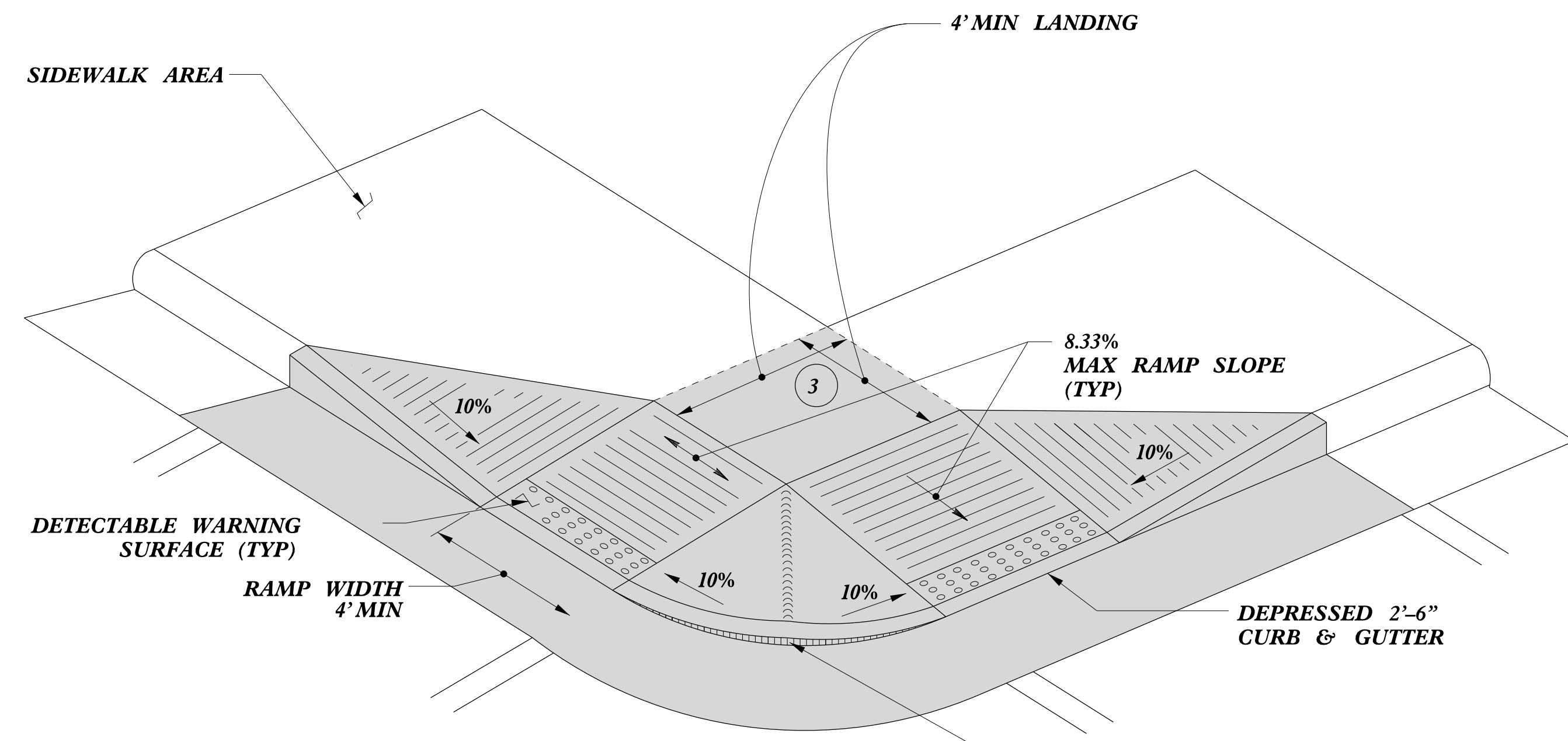

**TYPE 4**

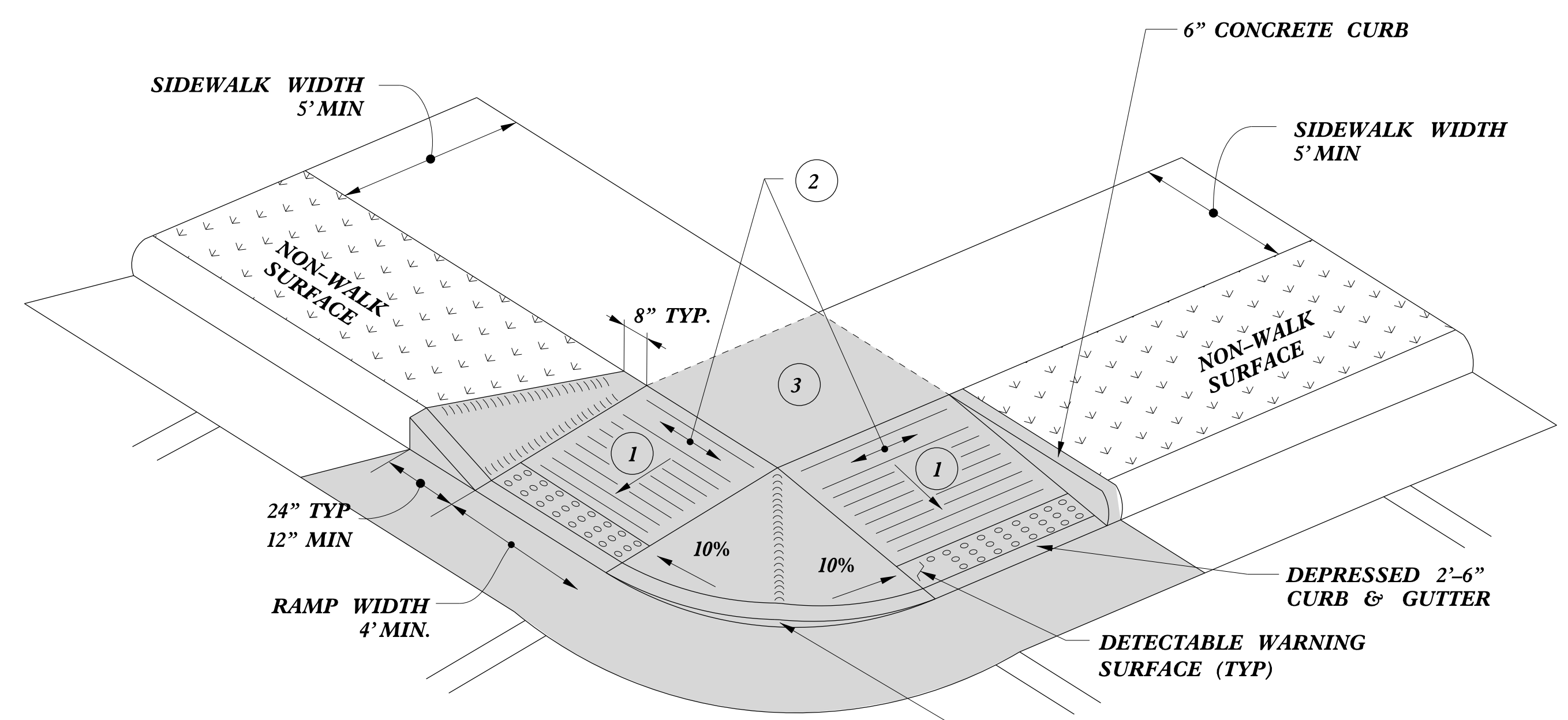

**TYPE 4A**

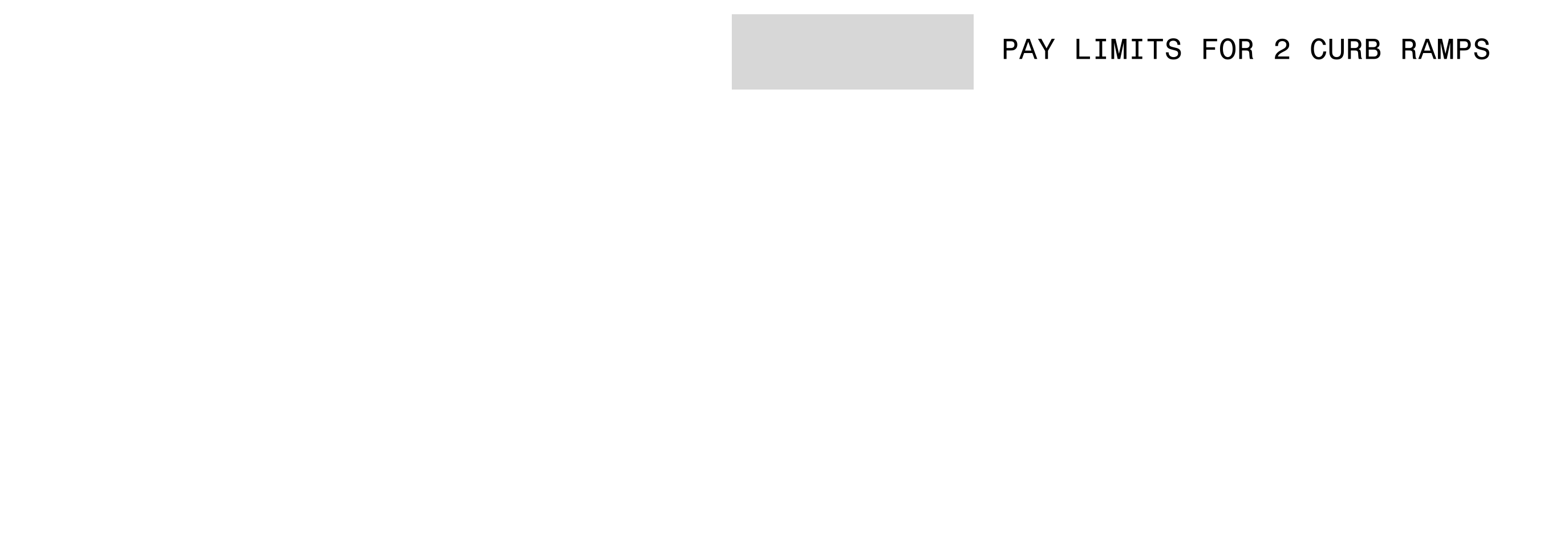

**TYPE 5**

- 1 8.33% (12:1) MAX RAMP SLOPE
- 2 CROSS SLOPE: 2.00%
- 3 CURB RAMPS REQUIRE A (4'-0") MINIMUM LANDING WITH A MAXIMUM CROSS SLOPE AND LONGITUDINAL SLOPE OF 2.00% WHERE PEDESTRIANS PERFORM TURNING MANEUVERS. SLOPE TO DRAIN TO CURB.



DOCUMENT NOT CONSIDERED FINAL UNLESS ALL SIGNATURES COMPLETED

<b>CONTRACT STANDARDS AND DEVELOPMENT UNIT</b>	
Office 919-707-6950	FAX 919-250-4119
<b>CURB RAMPS</b>	
Shared Landing	
ORIGINAL BY: J.S. HOWERTON	DATE: 7/7/11
MODIFIED BY:	DATE:
CHECKED BY:	DATE:
FILE SPEC: stds/2012CurbRamp/CurbRampDetails.dgn	

REFER TO ROADWAY STANDARD DRAWING NUMBER 848.05 SHEET 3 OF 3 FOR ALL RAMP NOTES

5/14/99  
C:\TIME\STDS\CON\CON\USER\NAME

**SUMMARY OF QUANTITIES - CUMBERLAND & HARNETT CO.**

PROJECT NO	COUNTY	MUNICIPALITY	MAJOR ROUTE	MINOR ROUTE	0000100000-N	1220000000-E	2549000000-E	2591000000-E	2600000000-N	2605000000-N	2612000000-E	2613000000-N	2800000000-N	2815000000-N	2830000000-N	4695000000-E	4891000000-E	NOTES
					Mobilization	Incidental Stone Base	2'-6" Concrete Curb & Gutter	4" Concrete Sidewalk (5' Wide)	Retrofit Existing Curb Ramp	Concrete Curb Ramp	6" Concrete Driveway	Remove & Replace Curb Ramps	Adjustments of Catch Basins	Adjustments of Drop Inlets	Adjustment of Manholes	Thermoplastic Pavement Marking Lines (8", 90 mils)	Thermoplastic Pavement Marking Lines (24", 90 mils)	
					LS	TON	LF	SY	EA	EA	SY	EA	EA	EA	EA	LF	LF	
44916.3.12	Cumberland	Fay. / Spring Lake	NC 210 (Lillington Hwy)	Cottageville Dr	0.5	10	5						1	1	1	25	25	
44916.3.12	Cumberland	Fay. / Spring Lake	NC 210 (Lillington Hwy)	Lake Park Dr			20						4					
44916.3.12	Cumberland	Fay. / Spring Lake	NC 210 (Lillington Hwy)	N 5th St			5			1								
44916.3.12	Cumberland	Fay. / Spring Lake	NC 210 (Lillington Hwy)	Pine Knoll Dr			10						2					
44916.3.12	Cumberland	Fay. / Spring Lake	NC 210 (Lillington Hwy)	Samuel Dr			10						2					
44916.3.12	Cumberland	Fay. / Spring Lake	NC 210 (Lillington Hwy)	Skyland Crosswalk 1			5						1					
44916.3.12	Cumberland	Fay. / Spring Lake	NC 210 (Lillington Hwy)	Skyland Crosswalk 2			10						2					
44916.3.12	Cumberland	Fay. / Spring Lake	NC 210 (Lillington Hwy)	Skyland Plaza DW 1			5						1					
44916.3.12	Cumberland	Fay. / Spring Lake	NC 210 (Lillington Hwy)	Skyland Plaza DW 2			10						2					
44916.3.12	Cumberland	Fay. / Spring Lake	NC 210 (Lillington Hwy)	Skyland Plaza DW 3			10						2					
44916.3.12	Cumberland	Fay. / Spring Lake	NC 210 (Lillington Hwy)	SR 1451 (E Manchester Rd)			15						3					
44916.3.12	Cumberland	Fay. / Spring Lake	NC 210 (Lillington Hwy)	SR 1601 (Chapel Hill Rd)			30						6					
44916.3.12	Cumberland	Fay. / Spring Lake	NC 210 (Lillington Hwy)	Watercliff Cir			5						1					
44916.3.12	Cumberland	Fay. / Spring Lake	NC 210 (Lillington Hwy)	Weaver St			10											
44916.3.12	Cumberland	Fay. / Spring Lake	NC 210 (Murchison Rd)	Advance Auto Parts DW					2									
44916.3.12	Cumberland	Fay. / Spring Lake	NC 210 (Murchison Rd)	Blue St			15			1								
44916.3.12	Cumberland	Fay. / Spring Lake	NC 210 (Murchison Rd)	Bronco Square Driveway			10						3					
44916.3.12	Cumberland	Fay. / Spring Lake	NC 210 (Murchison Rd)	Bullock St			5						2					
44916.3.12	Cumberland	Fay. / Spring Lake	NC 210 (Murchison Rd)	Carthage Dr			10						1					
44916.3.12	Cumberland	Fay. / Spring Lake	NC 210 (Murchison Rd)	Crosswalk at Langdon St			10						2					
44916.3.12	Cumberland	Fay. / Spring Lake	NC 210 (Murchison Rd)	Currie St			10						2					
44916.3.12	Cumberland	Fay. / Spring Lake	NC 210 (Murchison Rd)	Edgecombe Ave			10						2					
44916.3.12	Cumberland	Fay. / Spring Lake	NC 210 (Murchison Rd)	Enoch Ave			10						2					
44916.3.12	Cumberland	Fay. / Spring Lake	NC 210 (Murchison Rd)	Family Dollar Driveway			10						2					
44916.3.12	Cumberland	Fay. / Spring Lake	NC 210 (Murchison Rd)	Filter Plant Dr			5						1					
44916.3.12	Cumberland	Fay. / Spring Lake	NC 210 (Murchison Rd)	FSU DW Across fr Brmco Sq			10						2					
44916.3.12	Cumberland	Fay. / Spring Lake	NC 210 (Murchison Rd)	Gillis St			10						2					
44916.3.12	Cumberland	Fay. / Spring Lake	NC 210 (Murchison Rd)	Harbor Rd			10						2					
44916.3.12	Cumberland	Fay. / Spring Lake	NC 210 (Murchison Rd)	Jasper St			20						4					
44916.3.12	Cumberland	Fay. / Spring Lake	NC 210 (Murchison Rd)	Kingdom Impact Min DW 1			10						2					
44916.3.12	Cumberland	Fay. / Spring Lake	NC 210 (Murchison Rd)	Kingdom Impact Min DW 2			10						2					
44916.3.12	Cumberland	Fay. / Spring Lake	NC 210 (Murchison Rd)	Matthews St			10						2					
44916.3.12	Cumberland	Fay. / Spring Lake	NC 210 (Murchison Rd)	McLamb Dr			10						2					
44916.3.12	Cumberland	Fay. / Spring Lake	NC 210 (Murchison Rd)	MLK Jr Dr			10						2					
44916.3.12	Cumberland	Fay. / Spring Lake	NC 210 (Murchison Rd)	Murchison Market Pl DW					1									
44916.3.12	Cumberland	Fay. / Spring Lake	NC 210 (Murchison Rd)	Normal Ave			5						1					
44916.3.12	Cumberland	Fay. / Spring Lake	NC 210 (Murchison Rd)	Pamalee Dr Circle K DW			5						1					
44916.3.12	Cumberland	Fay. / Spring Lake	NC 210 (Murchison Rd)	Patina Ct			10						2					
44916.3.12	Cumberland	Fay. / Spring Lake	NC 210 (Murchison Rd)	Pennsylvania Ave			5						1					
44916.3.12	Cumberland	Fay. / Spring Lake	NC 210 (Murchison Rd)	Phillips St			15						3					
44916.3.12	Cumberland	Fay. / Spring Lake	NC 210 (Murchison Rd)	Rosemary Dr			20						4					
44916.3.12	Cumberland	Fay. / Spring Lake	NC 210 (Murchison Rd)	Rosewood Ave			5						1					
44916.3.12	Cumberland	Fay. / Spring Lake	NC 210 (Murchison Rd)	Sleepy Hollow Dr			5						1					
44916.3.12	Cumberland	Fay. / Spring Lake	NC 210 (Murchison Rd)	SR 1614 (Shaw Mill Rd)			5						1					
44916.3.12	Cumberland	Fay. / Spring Lake	NC 210 (Murchison Rd)	State Ave			5						1					
44916.3.12	Cumberland	Fay. / Spring Lake	NC 210 (Murchison Rd)	Waddell Dr			10						2					
44916.3.12	Cumberland	Fay. / Spring Lake	NC 24/87 (Bragg Blvd)	Bargain St			5						1					
44916.3.12	Cumberland	Fay. / Spring Lake	NC 24/87 (Bragg Blvd)	Barrington Cir			5			1			1					
44916.3.12	Cumberland	Fay. / Spring Lake	NC 24/87 (Bragg Blvd)	Batteries and Bulbs DW			10						2					
44916.3.12	Cumberland	Fay. / Spring Lake	NC 24/87 (Bragg Blvd)	Brook Ln			10						2					
44916.3.12	Cumberland	Fay. / Spring Lake	NC 24/87 (Bragg Blvd)	Cactus Creek Driveways			20						4					
44916.3.12	Cumberland	Fay. / Spring Lake	NC 24/87 (Bragg Blvd)	Carol St			10						2					
44916.3.12	Cumberland	Fay. / Spring Lake	NC 24/87 (Bragg Blvd)	Competition Auto Driveway			5											
44916.3.12	Cumberland	Fay. / Spring Lake	NC 24/87 (Bragg Blvd)	Deerfield Dr			10						2					
44916.3.12	Cumberland	Fay. / Spring Lake	NC 24/87 (Bragg Blvd)	Elm St			10						2					
44916.3.12	Cumberland	Fay. / Spring Lake	NC 24/87 (Bragg Blvd)	Flea Market DW 1			10						2					
44916.3.12	Cumberland	Fay. / Spring Lake	NC 24/87 (Bragg Blvd)	Flea Market DW 2			10						2					
44916.3.12	Cumberland	Fay. / Spring Lake	NC 24/87 (Bragg Blvd)	Freedom Memorial Park DW						1								
44916.3.12	Cumberland	Fay. / Spring Lake	NC 24/87 (Bragg Blvd)	Freedom Plaza Driveway			10						2					
44916.3.12	Cumberland	Fay. / Spring Lake	NC 24/87 (Bragg Blvd)	Frugal Cir			10						2					
44916.3.12	Cumberland	Fay. / Spring Lake	NC 24/87 (Bragg Blvd)	FSNB Driveway			10						2					
44916.3.12	Cumberland	Fay. / Spring Lake	NC 24/87 (Bragg Blvd)	Glenville Ave			10						2					
44916.3.12	Cumberland	Fay. / Spring Lake	NC 24/87 (Bragg Blvd)	Greenland Dr			10						2					
44916.3.12	Cumberland	Fay. / Spring Lake	NC 24/87 (Bragg Blvd)	Hampton Inn Driveway			10						2					
44916.3.12	Cumberland	Fay. / Spring Lake	NC 24/87 (Bragg Blvd)	Hay St			20			2			2					
44916.3.12	Cumberland	Fay. / Spring Lake	NC 24/87 (Bragg Blvd)	IHOP Driveway			10						2					
44916.3.12	Cumberland	Fay. / Spring Lake	NC 24/87 (Bragg Blvd)	Jiffy Lube Driveway			5						1					
44916.3.12	Cumberland	Fay. / Spring Lake	NC 24/87 (Bragg Blvd)	Johnson St			10						2					
44916.3.12	Cumberland	Fay. / Spring Lake	NC 24/87 (Bragg Blvd)	Joseph St			10						2					
44916.3.12	Cumberland	Fay. / Spring Lake	NC 24/87 (Bragg Blvd)	Leach Dr			5						1					



PROJECT	COUNTY	MUNICIPALITY	MAJOR ROUTE	MINOR ROUTE	0000100000-N	122000000-E	254900000-E	259100000-E	260000000-N	260500000-N	261200000-E	261300000-N	280000000-N	281500000-N	283000000-N	469500000-E	489100000-E	NOTES
					Mobilization	Incidental Stone Base	2'-6" Concrete Curb & Gutter	4" Concrete Sidewalk (5' Wide)	Retrofit Existing Curb Ramp	Concrete Curb Ramp	6" Concrete Driveway	Remove & Replace Curb Ramps	Adjustments of Catch Basins	Adjustments of Drop Inlets	Adjustment of Manholes	Thermoplastic Pavement Marking Lines (8", 90 mils)	Thermoplastic Pavement Marking Lines (24", 90 mils)	
44916.3.12	Cumberland	Fay. / Spring Lake	NC 24/87 (Bragg Blvd)	Living Water Church DW			10					2						
44916.3.12	Cumberland	Fay. / Spring Lake	NC 24/87 (Bragg Blvd)	Marathon Gas Driveway			15			3								
44916.3.12	Cumberland	Fay. / Spring Lake	NC 24/87 (Bragg Blvd)	McDonald's Driveway			5					1						
44916.3.12	Cumberland	Fay. / Spring Lake	NC 24/87 (Bragg Blvd)	McKenzie Rd			10		1			1						
44916.3.12	Cumberland	Fay. / Spring Lake	NC 24/87 (Bragg Blvd)	McPherson Ave					2									
44916.3.12	Cumberland	Fay. / Spring Lake	NC 24/87 (Bragg Blvd)	MLK NB Exit Ramp			5		1			1						
44916.3.12	Cumberland	Fay. / Spring Lake	NC 24/87 (Bragg Blvd)	MLK SB Entrance Ramp			5					1						
44916.3.12	Cumberland	Fay. / Spring Lake	NC 24/87 (Bragg Blvd)	MLK SB Exit Ramp			5					1						
44916.3.12	Cumberland	Fay. / Spring Lake	NC 24/87 (Bragg Blvd)	N 2nd St			10					2						
44916.3.12	Cumberland	Fay. / Spring Lake	NC 24/87 (Bragg Blvd)	NC 690 (Vass Rd)			35					7						
44916.3.12	Cumberland	Fay. / Spring Lake	NC 24/87 (Bragg Blvd)	New St			5					1						
44916.3.12	Cumberland	Fay. / Spring Lake	NC 24/87 (Bragg Blvd)	Pearl St			10					2						
44916.3.12	Cumberland	Fay. / Spring Lake	NC 24/87 (Bragg Blvd)	Pecan Dr			5		1			1						
44916.3.12	Cumberland	Fay. / Spring Lake	NC 24/87 (Bragg Blvd)	Powers Chevrolet Driveway					2									
44916.3.12	Cumberland	Fay. / Spring Lake	NC 24/87 (Bragg Blvd)	Pro Wash Driveway			10					2						
44916.3.12	Cumberland	Fay. / Spring Lake	NC 24/87 (Bragg Blvd)	River View Cemetery DW			5					1						
44916.3.12	Cumberland	Fay. / Spring Lake	NC 24/87 (Bragg Blvd)	Rose St			5					1						
44916.3.12	Cumberland	Fay. / Spring Lake	NC 24/87 (Bragg Blvd)	SecurCare Storage DW			10					2						
44916.3.12	Cumberland	Fay. / Spring Lake	NC 24/87 (Bragg Blvd)	Sleepy Dr			10					2						
44916.3.12	Cumberland	Fay. / Spring Lake	NC 24/87 (Bragg Blvd)	Sonic DW 1			10					2						
44916.3.12	Cumberland	Fay. / Spring Lake	NC 24/87 (Bragg Blvd)	Sonic DW 2			10					2						
44916.3.12	Cumberland	Fay. / Spring Lake	NC 24/87 (Bragg Blvd)	South Wind Plaza Driveway			10					2						
44916.3.12	Cumberland	Fay. / Spring Lake	NC 24/87 (Bragg Blvd)	Spring Lake Outpost DW			5			1								
44916.3.12	Cumberland	Fay. / Spring Lake	NC 24/87 (Bragg Blvd)	SR 1451 (W Manchester Rd)			10					2						
44916.3.12	Cumberland	Fay. / Spring Lake	NC 24/87 (Bragg Blvd)	SR 1601 (Chapel Hill Rd)			15					3						
44916.3.12	Cumberland	Fay. / Spring Lake	NC 24/87 (Bragg Blvd)	Starling St			10					2						
44916.3.12	Cumberland	Fay. / Spring Lake	NC 24/87 (Bragg Blvd)	Swain St (N Driveway)			10					2						
44916.3.12	Cumberland	Fay. / Spring Lake	NC 24/87 (Bragg Blvd)	Swain St (S Driveway)			10					2						
44916.3.12	Cumberland	Fay. / Spring Lake	NC 24/87 (Bragg Blvd)	Sycamore Square DW			10					2						
44916.3.12	Cumberland	Fay. / Spring Lake	NC 24/87 (Bragg Blvd)	Tally Ho Dr			10					2						
44916.3.12	Cumberland	Fay. / Spring Lake	NC 24/87 (Bragg Blvd)	Tophat St			5					1						
44916.3.12	Cumberland	Fay. / Spring Lake	NC 24/87 (Bragg Blvd)	Tram Rd			5					1						
44916.3.12	Cumberland	Fay. / Spring Lake	NC 24/87 (Bragg Blvd)	Tuscarora Dr			5					1						
44916.3.12	Cumberland	Fay. / Spring Lake	NC 24/87 (Bragg Blvd)	W Rowan St			10					2						
44916.3.12	Cumberland	Fay. / Spring Lake	NC 24/87 (Bragg Blvd)	William Clark Rd			10					2						
44916.3.12	Cumberland	Fay. / Spring Lake	NC 24/87 (Bragg Blvd)	Williams Chapel Ch DW			5			1								
44916.3.12	Cumberland	Fay. / Spring Lake	NC 24/87 (Bragg Blvd)	Young Cleaners DW 1			5			1								
44916.3.12	Cumberland	Fay. / Spring Lake	NC 24/87 (Bragg Blvd)	Young Cleaners DW 2			5			1								
44916.3.12	Cumberland	Fay. / Spring Lake	SR 1003 (Camden Rd)	SR 1141 (Cumberland Rd)				190										
44916.3.12	Cumberland	Fay. / Spring Lake	SR 1132 (Legion Road)	CVS @ SR 1344			10					2						
44916.3.12	Cumberland	Fay. / Spring Lake	SR 1132 (Legion Road)	Elizabeth Cashwell ES DW			5					1						
44916.3.12	Cumberland	Fay. / Spring Lake	SR 1132 (Legion Road)	McCasita's DW 1			10					2						
44916.3.12	Cumberland	Fay. / Spring Lake	SR 1132 (Legion Road)	SR 1344 (Black & Decker Rd)			20					4						
44916.3.12	Cumberland	Fay. / Spring Lake	SR 1141 (Southern Ave)	Craven St			10					2						
44916.3.12	Cumberland	Fay. / Spring Lake	SR 1141 (Southern Ave)	Cude St			20					4						
44916.3.12	Cumberland	Fay. / Spring Lake	SR 1141 (Southern Ave)	Dallas St			10					2						
44916.3.12	Cumberland	Fay. / Spring Lake	SR 1141 (Southern Ave)	Delcross St			20			2		2						
44916.3.12	Cumberland	Fay. / Spring Lake	SR 1141 (Southern Ave)	Eugene St			5					1						
44916.3.12	Cumberland	Fay. / Spring Lake	SR 1141 (Southern Ave)	Garvin St			5		1									
44916.3.12	Cumberland	Fay. / Spring Lake	SR 1141 (Southern Ave)	Hedgepeth St			10					2						
44916.3.12	Cumberland	Fay. / Spring Lake	SR 1141 (Southern Ave)	Heidelberg Dr			10					2						
44916.3.12	Cumberland	Fay. / Spring Lake	SR 1141 (Southern Ave)	Massey Hill BC Crosswalk			10			2								
44916.3.12	Cumberland	Fay. / Spring Lake	SR 1141 (Southern Ave)	Massey Hill HS Crosswalk			10			2								
44916.3.12	Cumberland	Fay. / Spring Lake	SR 1141 (Southern Ave)	May St			5					1						
44916.3.12	Cumberland	Fay. / Spring Lake	SR 1141 (Southern Ave)	Mayview St			5					1						
44916.3.12	Cumberland	Fay. / Spring Lake	SR 1141 (Southern Ave)	NC 162 (Elk Dr)			5					1						
44916.3.12	Cumberland	Fay. / Spring Lake	SR 1141 (Southern Ave)	NCDOT RE Driveway			10					2						
44916.3.12	Cumberland	Fay. / Spring Lake	SR 1141 (Southern Ave)	Poe St			10					2						
44916.3.12	Cumberland	Fay. / Spring Lake	SR 1141 (Southern Ave)	Princeton St			5			1								
44916.3.12	Cumberland	Fay. / Spring Lake	SR 1141 (Southern Ave)	Quality Rd			10			1		1						
44916.3.12	Cumberland	Fay. / Spring Lake	SR 1141 (Southern Ave)	RSJ Properties Driveway			5			2								
44916.3.12	Cumberland	Fay. / Spring Lake	SR 1141 (Southern Ave)	Southern Ave Warehouse			10					2						
44916.3.12	Cumberland	Fay. / Spring Lake	SR 1141 (Southern Ave)	Spencer Ave			10			2								
44916.3.12	Cumberland	Fay. / Spring Lake	SR 1141 (Southern Ave)	SR 1168 (Whitfield St)			10		2									
44916.3.12	Cumberland	Fay. / Spring Lake	SR 1141 (Southern Ave)	Tolar St			5					1						
44916.3.12	Cumberland	Fay. / Spring Lake	SR 1141 (Southern Ave)	W Oak St			10					2						
44916.3.12	Cumberland	Fay. / Spring Lake	SR 1141 (Southern Ave)	Whitfield St			10					2						
44916.3.12	Cumberland	Fay. / Spring Lake	SR 1141 (Southern Ave)	Winslow St			5					1						
44916.3.12	Cumberland	Fay. / Spring Lake	SR 1400 (Cliffdale Rd)	71st School Rd			20					4						
44916.3.12	Cumberland	Fay. / Spring Lake	SR 1400 (Cliffdale Rd)	71st School Rd BP Driveway			10					2						
44916.3.12	Cumberland	Fay. / Spring Lake	SR 1400 (Cliffdale Rd)	Alco Shell Gas Sta DW			10					2						
44916.3.12	Cumberland	Fay. / Spring Lake	SR 1400 (Cliffdale Rd)	Allensby Rd			10					2						
44916.3.12	Cumberland	Fay. / Spring Lake	SR 1400 (Cliffdale Rd)	Bartons Landing Pl			10					2						



PROJECT	COUNTY	MUNICIPALITY	MAJOR ROUTE	MINOR ROUTE	0000100000-N Mobilization	1220000000-E Incidental Stone Base	2549000000-E 2'-6" Concrete Curb & Gutter	2591000000-E 4" Concrete Sidewalk (5' Wide)	2600000000-N Retrofit Existing Curb Ramp	2605000000-N Concrete Curb Ramp	2612000000-E 6" Concrete Driveway	2613000000-N Remove & Replace Curb Ramps	2800000000-N Adjustments of Catch Basins	2815000000-N Adjustments of Drop Inlets	2830000000-N Adjustment of Manholes	4695000000-E Thermoplastic Pavement Marking Lines (8", 90 mils)	4891000000-E Thermoplastic Pavement Marking Lines (24", 90 mils)	NOTES
44916.3.12	Cumberland	Fay. / Spring Lake	SR 1400 (Cliffdale Rd)	Bassman Lane			10					2						
44916.3.12	Cumberland	Fay. / Spring Lake	SR 1400 (Cliffdale Rd)	Beaver Run Dr			10					2						
44916.3.12	Cumberland	Fay. / Spring Lake	SR 1400 (Cliffdale Rd)	Branchwood Cir			10					2						
44916.3.12	Cumberland	Fay. / Spring Lake	SR 1400 (Cliffdale Rd)	Brandermill Rd			10		2									
44916.3.12	Cumberland	Fay. / Spring Lake	SR 1400 (Cliffdale Rd)	Braybrooke Pl			10					2						
44916.3.12	Cumberland	Fay. / Spring Lake	SR 1400 (Cliffdale Rd)	Brookstone Ln			10					2						
44916.3.12	Cumberland	Fay. / Spring Lake	SR 1400 (Cliffdale Rd)	Buhmann Dr			10					2						
44916.3.12	Cumberland	Fay. / Spring Lake	SR 1400 (Cliffdale Rd)	Bunce Rd			10					4						
44916.3.12	Cumberland	Fay. / Spring Lake	SR 1400 (Cliffdale Rd)	Carlie C's Carwash DW			10					2						
44916.3.12	Cumberland	Fay. / Spring Lake	SR 1400 (Cliffdale Rd)	Carlson Bay Ct			10		2									
44916.3.12	Cumberland	Fay. / Spring Lake	SR 1400 (Cliffdale Rd)	Castle Rising Rd			10		2									
44916.3.12	Cumberland	Fay. / Spring Lake	SR 1400 (Cliffdale Rd)	Church Entrance			10		2									
44916.3.12	Cumberland	Fay. / Spring Lake	SR 1400 (Cliffdale Rd)	CL Tart Cir			5		1									
44916.3.12	Cumberland	Fay. / Spring Lake	SR 1400 (Cliffdale Rd)	Cliffdale Christian Center			10					2						
44916.3.12	Cumberland	Fay. / Spring Lake	SR 1400 (Cliffdale Rd)	Cliffdale Community Ch DW			10					2						
44916.3.12	Cumberland	Fay. / Spring Lake	SR 1400 (Cliffdale Rd)	Cliffdale Ct			15					3						
44916.3.12	Cumberland	Fay. / Spring Lake	SR 1400 (Cliffdale Rd)	Cliffdale Elementary DW 1			15					3						
44916.3.12	Cumberland	Fay. / Spring Lake	SR 1400 (Cliffdale Rd)	Cliffdale Elementary DW 2			10					2						
44916.3.12	Cumberland	Fay. / Spring Lake	SR 1400 (Cliffdale Rd)	Cliffdale Plaza Driveway			10					2						
44916.3.12	Cumberland	Fay. / Spring Lake	SR 1400 (Cliffdale Rd)	Clifford Ave			15					3						
44916.3.12	Cumberland	Fay. / Spring Lake	SR 1400 (Cliffdale Rd)	Cookout Driveway			10					2						
44916.3.12	Cumberland	Fay. / Spring Lake	SR 1400 (Cliffdale Rd)	Crescent Commons Way			10					2						
44916.3.12	Cumberland	Fay. / Spring Lake	SR 1400 (Cliffdale Rd)	Cutchen Ln			10					2						
44916.3.12	Cumberland	Fay. / Spring Lake	SR 1400 (Cliffdale Rd)	Enforcement Dr			5					1						
44916.3.12	Cumberland	Fay. / Spring Lake	SR 1400 (Cliffdale Rd)	Enterprise Driveway			20		4									
44916.3.12	Cumberland	Fay. / Spring Lake	SR 1400 (Cliffdale Rd)	Fast Mart Driveway			10		2									
44916.3.12	Cumberland	Fay. / Spring Lake	SR 1400 (Cliffdale Rd)	Glen Iris Dr			10					2						
44916.3.12	Cumberland	Fay. / Spring Lake	SR 1400 (Cliffdale Rd)	Hendrick Driveways			20		4									
44916.3.12	Cumberland	Fay. / Spring Lake	SR 1400 (Cliffdale Rd)	Hidden Creek Dr			10					2						
44916.3.12	Cumberland	Fay. / Spring Lake	SR 1400 (Cliffdale Rd)	Hoke Loop Walmart DW			5					1						
44916.3.12	Cumberland	Fay. / Spring Lake	SR 1400 (Cliffdale Rd)	Holland Park Ave			10					2						
44916.3.12	Cumberland	Fay. / Spring Lake	SR 1400 (Cliffdale Rd)	Jennings Farm Rd			20					4						
44916.3.12	Cumberland	Fay. / Spring Lake	SR 1400 (Cliffdale Rd)	JK Plaza Driveway			10			2								
44916.3.12	Cumberland	Fay. / Spring Lake	SR 1400 (Cliffdale Rd)	Laser Carwash Driveway			10					2						
44916.3.12	Cumberland	Fay. / Spring Lake	SR 1400 (Cliffdale Rd)	Leona Ave			20					4						
44916.3.12	Cumberland	Fay. / Spring Lake	SR 1400 (Cliffdale Rd)	Library Driveway			10					2						
44916.3.12	Cumberland	Fay. / Spring Lake	SR 1400 (Cliffdale Rd)	Loxley Dr			10					2						
44916.3.12	Cumberland	Fay. / Spring Lake	SR 1400 (Cliffdale Rd)	Manna Church Driveway			10					2						
44916.3.12	Cumberland	Fay. / Spring Lake	SR 1400 (Cliffdale Rd)	Mount Gilead Dr			20					4						
44916.3.12	Cumberland	Fay. / Spring Lake	SR 1400 (Cliffdale Rd)	Nelson Ave			20					4						
44916.3.12	Cumberland	Fay. / Spring Lake	SR 1400 (Cliffdale Rd)	Offing Dr			10					2						
44916.3.12	Cumberland	Fay. / Spring Lake	SR 1400 (Cliffdale Rd)	Palomar St			10		2									
44916.3.12	Cumberland	Fay. / Spring Lake	SR 1400 (Cliffdale Rd)	Prestige Blvd			10					2						
44916.3.12	Cumberland	Fay. / Spring Lake	SR 1400 (Cliffdale Rd)	Pritchett Rd			20					4						
44916.3.12	Cumberland	Fay. / Spring Lake	SR 1400 (Cliffdale Rd)	Raven Pl			10					2						
44916.3.12	Cumberland	Fay. / Spring Lake	SR 1400 (Cliffdale Rd)	Regency Dr			10					2						
44916.3.12	Cumberland	Fay. / Spring Lake	SR 1400 (Cliffdale Rd)	Saint Mary's Pkwy			10		2									
44916.3.12	Cumberland	Fay. / Spring Lake	SR 1400 (Cliffdale Rd)	Scottsdale Dr			10		2									
44916.3.12	Cumberland	Fay. / Spring Lake	SR 1400 (Cliffdale Rd)	Scottsdale Dr			10					2						
44916.3.12	Cumberland	Fay. / Spring Lake	SR 1400 (Cliffdale Rd)	Seaford Dr			10		2									
44916.3.12	Cumberland	Fay. / Spring Lake	SR 1400 (Cliffdale Rd)	Seaford Dr			10					2						
44916.3.12	Cumberland	Fay. / Spring Lake	SR 1400 (Cliffdale Rd)	Shadow Oak Ln			10		2									
44916.3.12	Cumberland	Fay. / Spring Lake	SR 1400 (Cliffdale Rd)	SR 1007 (AA Fwy) Entr			10		2									
44916.3.12	Cumberland	Fay. / Spring Lake	SR 1400 (Cliffdale Rd)	SR 1007 (AA Fwy) Exit			20		4									
44916.3.12	Cumberland	Fay. / Spring Lake	SR 1400 (Cliffdale Rd)	SR 1593 (Hoke Loop Dr)			5					1						
44916.3.12	Cumberland	Fay. / Spring Lake	SR 1400 (Cliffdale Rd)	Sunny Plaza DW 1			5					1						
44916.3.12	Cumberland	Fay. / Spring Lake	SR 1400 (Cliffdale Rd)	Sunny Plaza DW 2			10					2						
44916.3.12	Cumberland	Fay. / Spring Lake	SR 1400 (Cliffdale Rd)	Sutton St			5		1									
44916.3.12	Cumberland	Fay. / Spring Lake	SR 1400 (Cliffdale Rd)	Suzanne St			5		1									
44916.3.12	Cumberland	Fay. / Spring Lake	SR 1400 (Cliffdale Rd)	Taco Bell Driveway			15					3						
44916.3.12	Cumberland	Fay. / Spring Lake	SR 1400 (Cliffdale Rd)	True Vine Ministries DW 1			10		2									
44916.3.12	Cumberland	Fay. / Spring Lake	SR 1400 (Cliffdale Rd)	True Vine Ministries DW 2			10		2									
44916.3.12	Cumberland	Fay. / Spring Lake	SR 1400 (Cliffdale Rd)	True Vine Ministries DW 3			10		2									
44916.3.12	Cumberland	Fay. / Spring Lake	SR 1400 (Cliffdale Rd)	USPS Driveway			5					1						
44916.3.12	Cumberland	Fay. / Spring Lake	SR 1400 (Cliffdale Rd)	Waters Edge Dr			5					1						
44916.3.12	Cumberland	Fay. / Spring Lake	SR 1400 (Cliffdale Rd)	Wayah Creek Dr			10		2									
44916.3.12	Cumberland	Fay. / Spring Lake	SR 1400 (Cliffdale Rd)	Wonder Years Daycare DW			10					2						
44916.3.12	Cumberland	Fay. / Spring Lake	SR 1400 (Cliffdale Rd)	Woodspring Suites			10					2						
44916.3.12	Cumberland	Fay. / Spring Lake	SR 1403 (Reilly Rd)	Bridgeman Dr			5		1									
44916.3.12	Cumberland	Fay. / Spring Lake	SR 1403 (Reilly Rd)	Crown Ave			5		1									
44916.3.12	Cumberland	Fay. / Spring Lake	SR 1403 (Reilly Rd)	E Hampton Rd			30		6									
44916.3.12	Cumberland	Fay. / Spring Lake	SR 1403 (Reilly Rd)	Fairvale Dr			5		1									
44916.3.12	Cumberland	Fay. / Spring Lake	SR 1403 (Reilly Rd)	Fillyaw Rd			10		2									

PROJECT	COUNTY	MUNICIPALITY	MAJOR ROUTE	MINOR ROUTE	0000100000-N Mobilization	122000000-E Incidental Stone Base	254900000-E 2'-6" Concrete Curb & Gutter	259100000-E 4" Concrete Sidewalk (5' Wide)	260000000-N Retrofit Existing Curb Ramp	260500000-N Concrete Curb Ramp	261200000-E 6" Concrete Driveway	261300000-N Remove & Replace Curb Ramps	280000000-N Adjustments of Catch Basins	281500000-N Adjustments of Drop Inlets	283000000-N Adjustment of Manholes	469500000-E Thermoplastic Pavement Marking Lines (8", 90 mils)	489100000-E Thermoplastic Pavement Marking Lines (24", 90 mils)	NOTES
44916.3.12	Cumberland	Fay. / Spring Lake	SR 1403 (Reilly Rd)	Highlander Rentals Driveway			5		1									
44916.3.12	Cumberland	Fay. / Spring Lake	SR 1403 (Reilly Rd)	Overbrook Dr			10		2									
44916.3.12	Cumberland	Fay. / Spring Lake	SR 1403 (Reilly Rd)	Paxton Dr			25		5									
44916.3.12	Cumberland	Fay. / Spring Lake	SR 1403 (Reilly Rd)	Riegelwood St			20		4									
44916.3.12	Cumberland	Fay. / Spring Lake	SR 1403 (Reilly Rd)	Secure Care Driveway			10		2									
44916.3.12	Cumberland	Fay. / Spring Lake	SR 1403 (Reilly Rd)	SR 1437 (Santa Fe Dr)			5		1									
44916.3.12	Cumberland	Fay. / Spring Lake	SR 1404 (Hay St)	Highland Ave			5					1						
44916.3.12	Cumberland	Fay. / Spring Lake	SR 1404 (Hay St)	Highland Presbyterian Ch DW			20					4						
44916.3.12	Cumberland	Fay. / Spring Lake	SR 1404 (Hay St)	Hinsdale Ave			5					1						Subject to Historic/Cultural Review. May be Deleted from Contract.
44916.3.12	Cumberland	Fay. / Spring Lake	SR 1404 (Hay St)	MLK Entrance			20					4						
44916.3.12	Cumberland	Fay. / Spring Lake	SR 1404 (Hay St)	MLK Exit			15					3						
44916.3.12	Cumberland	Fay. / Spring Lake	SR 1404 (Hay St)	Myrover St			10					2						
44916.3.12	Cumberland	Fay. / Spring Lake	SR 1404 (Hay St)	Myrtle St			10					2						
44916.3.12	Cumberland	Fay. / Spring Lake	SR 1404 (Hay St)	Spring St			10					2						Subject to Historic/Cultural Review. May be Deleted from Contract.
44916.3.12	Cumberland	Fay. / Spring Lake	SR 1404 (Morganton Rd)	Arbor View Ct			10					2						
44916.3.12	Cumberland	Fay. / Spring Lake	SR 1404 (Morganton Rd)	Arby's Driveway			10					2						
44916.3.12	Cumberland	Fay. / Spring Lake	SR 1404 (Morganton Rd)	Baskin Robbins Driveway			10		2									
44916.3.12	Cumberland	Fay. / Spring Lake	SR 1404 (Morganton Rd)	Basking Ridge Dr			10					2						
44916.3.12	Cumberland	Fay. / Spring Lake	SR 1404 (Morganton Rd)	BB & T Driveway			5					1						
44916.3.12	Cumberland	Fay. / Spring Lake	SR 1404 (Morganton Rd)	Bethune St			10					2						
44916.3.12	Cumberland	Fay. / Spring Lake	SR 1404 (Morganton Rd)	Bullard Furniture Driveway			15		3									
44916.3.12	Cumberland	Fay. / Spring Lake	SR 1404 (Morganton Rd)	Camellia Dr			10					2						
44916.3.12	Cumberland	Fay. / Spring Lake	SR 1404 (Morganton Rd)	Churchhill Dr			10					2						
44916.3.12	Cumberland	Fay. / Spring Lake	SR 1404 (Morganton Rd)	Courtyard Ln			10					2						
44916.3.12	Cumberland	Fay. / Spring Lake	SR 1404 (Morganton Rd)	Cross Creek Dental DW			10					2						
44916.3.12	Cumberland	Fay. / Spring Lake	SR 1404 (Morganton Rd)	Cross Creek Mall DW 1			20					4						
44916.3.12	Cumberland	Fay. / Spring Lake	SR 1404 (Morganton Rd)	Cross Creek Mall DW 2			20					4						
44916.3.12	Cumberland	Fay. / Spring Lake	SR 1404 (Morganton Rd)	Devane St			5					1						Subject to Historic/Cultural Review. May be Deleted from Contract.
44916.3.12	Cumberland	Fay. / Spring Lake	SR 1404 (Morganton Rd)	Dobbin Ave			10					2						
44916.3.12	Cumberland	Fay. / Spring Lake	SR 1404 (Morganton Rd)	Dundee Rd			10					2						
44916.3.12	Cumberland	Fay. / Spring Lake	SR 1404 (Morganton Rd)	E Dobbin Ave			10					2						
44916.3.12	Cumberland	Fay. / Spring Lake	SR 1404 (Morganton Rd)	E Loch Haven Dr			20					4						
44916.3.12	Cumberland	Fay. / Spring Lake	SR 1404 (Morganton Rd)	Ellerslie Dr			10					2						
44916.3.12	Cumberland	Fay. / Spring Lake	SR 1404 (Morganton Rd)	Ellington St			5					1						
44916.3.12	Cumberland	Fay. / Spring Lake	SR 1404 (Morganton Rd)	Farmbrook Rd			10					2						
44916.3.12	Cumberland	Fay. / Spring Lake	SR 1404 (Morganton Rd)	Granville Dr			10					2						
44916.3.12	Cumberland	Fay. / Spring Lake	SR 1404 (Morganton Rd)	Haymont Auto Driveway			10		2									
44916.3.12	Cumberland	Fay. / Spring Lake	SR 1404 (Morganton Rd)	Hearthstone Dr			30					6						
44916.3.12	Cumberland	Fay. / Spring Lake	SR 1404 (Morganton Rd)	Hemdon St			10					2						
44916.3.12	Cumberland	Fay. / Spring Lake	SR 1404 (Morganton Rd)	Kendalwood Dr			20					4						
44916.3.12	Cumberland	Fay. / Spring Lake	SR 1404 (Morganton Rd)	KFC Driveway			5		1									
44916.3.12	Cumberland	Fay. / Spring Lake	SR 1404 (Morganton Rd)	Kick Back Jacks Driveway			10					2						
44916.3.12	Cumberland	Fay. / Spring Lake	SR 1404 (Morganton Rd)	Lamb St			10					2						
44916.3.12	Cumberland	Fay. / Spring Lake	SR 1404 (Morganton Rd)	LDS Church DW 1			10					2						
44916.3.12	Cumberland	Fay. / Spring Lake	SR 1404 (Morganton Rd)	Longbranch Dr			20					4						
44916.3.12	Cumberland	Fay. / Spring Lake	SR 1404 (Morganton Rd)	Marketfair Driveway			5					1						
44916.3.12	Cumberland	Fay. / Spring Lake	SR 1404 (Morganton Rd)	McFayden Dr			5					1						
44916.3.12	Cumberland	Fay. / Spring Lake	SR 1404 (Morganton Rd)	Mcperson Ch.			15		3									
44916.3.12	Cumberland	Fay. / Spring Lake	SR 1404 (Morganton Rd)	Murray Fork Clinic DW			5					1						
44916.3.12	Cumberland	Fay. / Spring Lake	SR 1404 (Morganton Rd)	N Hemdon St			10		2									
44916.3.12	Cumberland	Fay. / Spring Lake	SR 1404 (Morganton Rd)	N Olive Rd			5					1						
44916.3.13	Cumberland	Fay. / Spring Lake	SR 1404 (Morganton Rd)	Old Farm Rd			10					2						
44916.3.14	Cumberland	Fay. / Spring Lake	SR 1404 (Morganton Rd)	Old Gate Rd			30					6						
44916.3.15	Cumberland	Fay. / Spring Lake	SR 1404 (Morganton Rd)	Pate Dr			10					2						
44916.3.16	Cumberland	Fay. / Spring Lake	SR 1404 (Morganton Rd)	Red Robin Driveway			10		2									
44916.3.17	Cumberland	Fay. / Spring Lake	SR 1404 (Morganton Rd)	Rite Aid Driveway			5		1									
44916.3.18	Cumberland	Fay. / Spring Lake	SR 1404 (Morganton Rd)	Ruritan Dr			25					5						
44916.3.19	Cumberland	Fay. / Spring Lake	SR 1404 (Morganton Rd)	Seven Oaks Ct			10					2						
44916.3.20	Cumberland	Fay. / Spring Lake	SR 1404 (Morganton Rd)	Shadow Oak Ln			10					2						
44916.3.21	Cumberland	Fay. / Spring Lake	SR 1404 (Morganton Rd)	Shadsford Blvd			10					2						
44916.3.22	Cumberland	Fay. / Spring Lake	SR 1404 (Morganton Rd)	Skye Dr			10					2						
44916.3.23	Cumberland	Fay. / Spring Lake	SR 1404 (Morganton Rd)	SR 1007 (AA Fwy) NB Entr			15					3						
44916.3.24	Cumberland	Fay. / Spring Lake	SR 1404 (Morganton Rd)	SR 1007 (AA Fwy) NB Exit			5					1						
44916.3.25	Cumberland	Fay. / Spring Lake	SR 1404 (Morganton Rd)	SR 1007 (AA Fwy) SB Ent			10					2						
44916.3.26	Cumberland	Fay. / Spring Lake	SR 1404 (Morganton Rd)	SR 1007 (AA Fwy) SB Exit			10					2						
44916.3.27	Cumberland	Fay. / Spring Lake	SR 1404 (Morganton Rd)	SR 1408 (Bonanza Dr)			1					1						
44916.3.28	Cumberland	Fay. / Spring Lake	SR 1404 (Morganton Rd)	St Marys Pkwy			10					2						

PROJECT	COUNTY	MUNICIPALITY	MAJOR ROUTE	MINOR ROUTE	0000100000-N	1220000000-E	2549000000-E	2591000000-E	2600000000-N	2605000000-N	2612000000-E	2613000000-N	2800000000-N	2815000000-N	2830000000-N	4695000000-E	4891000000-E	NOTES
					Mobilization	Incidental Stone Base	2'-6" Concrete Curb & Gutter	4" Concrete Sidewalk (5' Wide)	Retrofit Existing Curb Ramp	Concrete Curb Ramp	6" Concrete Driveway	Remove & Replace Curb Ramps	Adjustments of Catch Basins	Adjustments of Drop Inlets	Adjustment of Manholes	Thermoplastic Pavement Marking Lines (8", 90 mils)	Thermoplastic Pavement Marking Lines (24", 90 mils)	
44916.3.29	Cumberland	Fay. / Spring Lake	SR 1404 (Morganton Rd)	Super Compare Food DW			10		2									
44916.3.30	Cumberland	Fay. / Spring Lake	SR 1404 (Morganton Rd)	Super Compare Foods DW			10					2						
44916.3.31	Cumberland	Fay. / Spring Lake	SR 1404 (Morganton Rd)	Sutton St			5					1						
44916.3.32	Cumberland	Fay. / Spring Lake	SR 1404 (Morganton Rd)	Sycamore Dairy Rd			10					2						
44916.3.33	Cumberland	Fay. / Spring Lake	SR 1404 (Morganton Rd)	True Vine Ministries DW 1			10					2						
44916.3.34	Cumberland	Fay. / Spring Lake	SR 1404 (Morganton Rd)	True Vine Ministries DW 2			10					2						
44916.3.35	Cumberland	Fay. / Spring Lake	SR 1404 (Morganton Rd)	True Vine Ministries DW 3			10					2						
44916.3.36	Cumberland	Fay. / Spring Lake	SR 1404 (Morganton Rd)	W Dobbin Ave			10					2						
44916.3.37	Cumberland	Fay. / Spring Lake	SR 1404 (Morganton Rd)	Wayah Creek Dr			10		1			1						
44916.3.38	Cumberland	Fay. / Spring Lake	SR 1404 (Morganton Rd)	Westlake Rd			15					3						
44916.3.39	Cumberland	Fay. / Spring Lake	SR 1404 (Morganton Rd)	Westwood Shopping Ctr DW			10					2						
44916.3.40	Cumberland	Fay. / Spring Lake	SR 1404 (Morganton Rd)	Wickliffe			10					2						
44916.3.41	Cumberland	Fay. / Spring Lake	SR 1404 (Morganton Rd)	Woodcreek Place			5					1						
44916.3.42	Cumberland	Fay. / Spring Lake	SR 1404 (Morganton Rd)	Woodrow St			10					2						
44916.3.43	Cumberland	Fay. / Spring Lake	SR 1408 (Bonanza Dr)	Cartwright Dr			10		2									
44916.3.44	Cumberland	Fay. / Spring Lake	SR 1408 (Bonanza Dr)	Foxfire Rd			10		2									
44916.3.45	Cumberland	Fay. / Spring Lake	SR 1408 (Bonanza Dr)	Pre-School Driveway			15		3									
44916.3.46	Cumberland	Fay. / Spring Lake	SR 1408 (Bonanza Dr)	Super Compare Foods DW			20		4									
44916.3.47	Cumberland	Fay. / Spring Lake	SR 1415 (Yadkin Rd)	All American Freeway				160		4								Phillippines Store & Cuisine
44916.3.48	Cumberland	Fay. / Spring Lake	SR 1415 (Yadkin Rd)	Big Apple Restaurant DW			10		2									
44916.3.49	Cumberland	Fay. / Spring Lake	SR 1415 (Yadkin Rd)	Brookfield Rd			10		2									
44916.3.50	Cumberland	Fay. / Spring Lake	SR 1415 (Yadkin Rd)	Cimarron Dr			10		2									
44916.3.51	Cumberland	Fay. / Spring Lake	SR 1415 (Yadkin Rd)	Gamestop Driveway			10		2									
44916.3.52	Cumberland	Fay. / Spring Lake	SR 1415 (Yadkin Rd)	Homestead Dr			10		2									
44916.3.53	Cumberland	Fay. / Spring Lake	SR 1415 (Yadkin Rd)	Horseshoe Road			5			1								
44916.3.54	Cumberland	Fay. / Spring Lake	SR 1415 (Yadkin Rd)	Kids Care Pediatric DW			10		2									
44916.3.55	Cumberland	Fay. / Spring Lake	SR 1415 (Yadkin Rd)	Kim's Barber Shop DW			5		1									
44916.3.56	Cumberland	Fay. / Spring Lake	SR 1415 (Yadkin Rd)	Kim's Sewing DW			5		1									
44916.3.57	Cumberland	Fay. / Spring Lake	SR 1415 (Yadkin Rd)	N Platte Rd			10		2									
44916.3.58	Cumberland	Fay. / Spring Lake	SR 1415 (Yadkin Rd)	O'Reilly Auto Parts DW			5		1									
44916.3.59	Cumberland	Fay. / Spring Lake	SR 1415 (Yadkin Rd)	Pima Dr			5		1									
44916.3.60	Cumberland	Fay. / Spring Lake	SR 1415 (Yadkin Rd)	SR 1437 (Santa Fe Dr)			20		4									
44916.3.61	Cumberland	Fay. / Spring Lake	SR 1415 (Yadkin Rd)	SR 3499 (Lake Valley Dr)			20			4								
44916.3.62	Cumberland	Fay. / Spring Lake	SR 1415 (Yadkin Rd)	Taco Bell Driveway			5		1									
44916.3.63	Cumberland	Fay. / Spring Lake	SR 1437 (Santa Fe Dr)	Advance Auto Driveway			10		2									
44916.3.64	Cumberland	Fay. / Spring Lake	SR 1437 (Santa Fe Dr)	Auto Zone Driveway			10		2									
44916.3.65	Cumberland	Fay. / Spring Lake	SR 1437 (Santa Fe Dr)	Carson Dr			25		5									
44916.3.66	Cumberland	Fay. / Spring Lake	SR 1437 (Santa Fe Dr)	Coalition Blvd			10		2									
44916.3.67	Cumberland	Fay. / Spring Lake	SR 1437 (Santa Fe Dr)	Cude St			20		4									
44916.3.68	Cumberland	Fay. / Spring Lake	SR 1437 (Santa Fe Dr)	Dodge Driveway			10		2									
44916.3.69	Cumberland	Fay. / Spring Lake	SR 1437 (Santa Fe Dr)	Exxon Driveway			10		2									
44916.3.70	Cumberland	Fay. / Spring Lake	SR 1437 (Santa Fe Dr)	Glenrock Dr			15		3									
44916.3.71	Cumberland	Fay. / Spring Lake	SR 1437 (Santa Fe Dr)	McDonald's Driveway			10		2									
44916.3.72	Cumberland	Fay. / Spring Lake	SR 1437 (Santa Fe Dr)	Mesa Dr			10		2									
44916.3.73	Cumberland	Fay. / Spring Lake	SR 1437 (Santa Fe Dr)	Plantation Garden			20		4									
44916.3.74	Cumberland	Fay. / Spring Lake	SR 1437 (Santa Fe Dr)	SR 1415 (Yadkin Dr)			15		3									
44916.3.75	Cumberland	Fay. / Spring Lake	SR 1449 (Main St)	Credit Union Driveway			10					2						
44916.3.76	Cumberland	Fay. / Spring Lake	SR 1449 (Main St)	Hendon St			5					1						
44916.3.77	Cumberland	Fay. / Spring Lake	SR 1449 (Main St)	Kaye St			5					1						
44916.3.78	Cumberland	Fay. / Spring Lake	SR 1449 (Main St)	NC 24/87 (Bragg Blvd)			10					2						
44916.3.79	Cumberland	Fay. / Spring Lake	SR 1449 (Main St)	Ruth St			5					1						
44916.3.80	Cumberland	Fay. / Spring Lake	SR 1449 (Main St)	Scarborough St			5					1						
44916.3.81	Cumberland	Fay. / Spring Lake	SR 1449 (Main St)	Spring Ave			10			1		1						
44916.3.82	Cumberland	Fay. / Spring Lake	SR 2299 (Russell St)	Alexander St			10					2						
44916.3.83	Cumberland	Fay. / Spring Lake	SR 2299 (Russell St)	Burns St			10		1	1								
44916.3.84	Cumberland	Fay. / Spring Lake	SR 2299 (Russell St)	C St			15			1		2						
44916.3.85	Cumberland	Fay. / Spring Lake	SR 2299 (Russell St)	Cross Creek St			5					1						
44916.3.86	Cumberland	Fay. / Spring Lake	SR 2299 (Russell St)	Day and Night AC DW			10					2						
44916.3.87	Cumberland	Fay. / Spring Lake	SR 2299 (Russell St)	Donaldson St			5					1						
44916.3.88	Cumberland	Fay. / Spring Lake	SR 2299 (Russell St)	Kennedy St			10					2						
44916.3.89	Cumberland	Fay. / Spring Lake	SR 2299 (Russell St)	Old Wilmington Rd			20					4						
44916.3.90	Cumberland	Fay. / Spring Lake	SR 2299 (Russell St)	O'Reilly Auto Parts DW			10					2						
44916.3.91	Cumberland	Fay. / Spring Lake	SR 2299 (Russell St)	S Cool Spring St			25		1			4						
44916.3.92	Cumberland	Fay. / Spring Lake	SR 2299 (Russell St)	SR 2311 (Gillespie St)			10		1			1						
44916.3.93	Cumberland	Fay. / Spring Lake	SR 2299 (Russell St)	Wayde St			10					2						
44916.3.94	Cumberland	Fay. / Spring Lake	SR 2299 (Russell St)	Williams St			20					4						
44916.3.95	Cumberland	Fay. / Spring Lake	SR 2299 (Russell St)	Worth St			5					1						
44916.3.96	Cumberland	Fay. / Spring Lake	SR 3828 (Robeson St)	Blount St			10					2						
44916.3.97	Cumberland	Fay. / Spring Lake	SR 3828 (Robeson St)	Franklin St			10					2						
44916.3.98	Cumberland	Fay. / Spring Lake	SR 3828 (Robeson St)	German St			5		1			1						
44916.3.99	Cumberland	Fay. / Spring Lake	SR 3828 (Robeson St)	Hay St			15		1			2						
44916.3.100	Cumberland	Fay. / Spring Lake	SR 3828 (Robeson St)	Highsmith Hospital DW 1			10					2						
44916.3.101	Cumberland	Fay. / Spring Lake	SR 3828 (Robeson St)	Highsmith Hospital DW 2			10					2						

PROJECT	COUNTY	MUNICIPALITY	MAJOR ROUTE	MINOR ROUTE	0000100000-N Mobilization	122000000-E Incidental Stone Base	254900000-E 2'-6" Concrete Curb & Gutter	259100000-E 4" Concrete Sidewalk (5' Wide)	260000000-N Retrofit Existing Curb Ramp	260500000-N Concrete Curb Ramp	261200000-E 6" Concrete Driveway	261300000-N Remove & Replace Curb Ramps	280000000-N Adjustments of Catch Basins	281500000-N Adjustments of Drop Inlets	283000000-N Adjustment of Manholes	469500000-E Thermoplastic Pavement Marking Lines (8", 90 mils)	489100000-E Thermoplastic Pavement Marking Lines (24", 90 mils)	NOTES
44916.3.102	Cumberland	Fay. / Spring Lake	SR 3828 (Robeson St)	Humphrey Ln			10					2						
44916.3.103	Cumberland	Fay. / Spring Lake	SR 3828 (Robeson St)	Medical Arts Center DW			10					2						
44916.3.104	Cumberland	Fay. / Spring Lake	SR 3828 (Robeson St)	Mihwa's Salon Driveway			10					2						
44916.3.105	Cumberland	Fay. / Spring Lake	SR 3828 (Robeson St)	MLK NB Exit Ramp			5					1						
44916.3.106	Cumberland	Fay. / Spring Lake	SR 3828 (Robeson St)	Tyson Commercial Driveway			10					2						
44916.3.107	Cumberland	Fay. / Spring Lake	SR 3950 (Ramsey St)	Health Dept Driveway			10		2									
44916.3.108	Cumberland	Fay. / Spring Lake	SR 3950 (Ramsey St)	Hillsboro St			10		2									
44916.3.109	Cumberland	Fay. / Spring Lake	SR 3950 (Ramsey St)	Quincy St			10		2									
44916.3.110	Cumberland	Fay. / Spring Lake	SR 3950 (Ramsey St)	Scott Ave			5		1									
44916.3.111	Cumberland	Fay. / Spring Lake	SR 3950 (Ramsey St)	VA Hospital Driveway			10		2									
44916.3.112	Cumberland	Fay. / Spring Lake	SR 3950 (Ramsey St)	Wall St			15		3									
44916.3.113	Cumberland	Fay. / Spring Lake	SR 3950 (Ramsey St)	Williston St			10		2									
44916.3.114	Cumberland	Fay. / Spring Lake	US 401 (Ramsey St)	Eastwood Ave			10		2									
44916.3.115	Cumberland	Fay. / Spring Lake	US 401 (Ramsey St)	Facility Dr			10		2									
44916.3.116	Cumberland	Fay. / Spring Lake	US 401 (Ramsey St)	Mary St			10			2								
44916.3.117	Cumberland	Fay. / Spring Lake	US 401 (Ramsey St)	Peace St			5		1									
44916.3.118	Cumberland	Fay. / Spring Lake	US 401 (Ramsey St)	SR 1007 (All American Fwy)			10		2									
44916.3.119	Cumberland	Fay. / Spring Lake	US 401 (Ramsey St)	Telegraph Cir			10		2									
44916.3.120	Cumberland	Fay. / Spring Lake	US 401 BUS (Raeford Rd)	Emeline Ave			10		1	1								
44916.3.121	Cumberland	Fay. / Spring Lake	US 401 BUS (Raeford Rd)	McPhee Dr			20		2	2								
44916.3.122	Cumberland	Fay. / Spring Lake	US 401 Bus (Robeson St)	Commerce St			5					1						
44916.3.123	Cumberland	Fay. / Spring Lake	US 401 Bus (Robeson St)	Lane Dentistry Office DW			10					2						
44916.3.124	Cumberland	Fay. / Spring Lake	US 401 Bus (Robeson St)	Robeson Bend Driveway			5					1						
44916.3.125	Cumberland	Fay. / Spring Lake	US 401 Bus (Robeson St)	Robeson Plaza Driveway					2									
44916.3.126	Cumberland	Fay. / Spring Lake	US 401 Bypass	Arby's Driveway			10		2									
44916.3.127	Cumberland	Fay. / Spring Lake	US 401 Bypass	Best Buy Driveway			10		2									
44916.3.128	Cumberland	Fay. / Spring Lake	US 401 Bypass	Boston Market Driveway			5		1									
44916.3.129	Cumberland	Fay. / Spring Lake	US 401 Bypass	Burger King Driveway			10		2									
44916.3.130	Cumberland	Fay. / Spring Lake	US 401 Bypass	Cadillac of Fayetteville DW			20		4									
44916.3.131	Cumberland	Fay. / Spring Lake	US 401 Bypass	Cain Rd			20		4									
44916.3.132	Cumberland	Fay. / Spring Lake	US 401 Bypass	Coralee Dr			10		2									
44916.3.133	Cumberland	Fay. / Spring Lake	US 401 Bypass	Cross Creek Mall			20		4									
44916.3.134	Cumberland	Fay. / Spring Lake	US 401 Bypass	Cross Creek Mall (SE)			20		4									
44916.3.135	Cumberland	Fay. / Spring Lake	US 401 Bypass	Exxon Driveway			10		2									
44916.3.136	Cumberland	Fay. / Spring Lake	US 401 Bypass	Exxon Driveway			10		2									
44916.3.137	Cumberland	Fay. / Spring Lake	US 401 Bypass	Gables Dr			10		2									
44916.3.138	Cumberland	Fay. / Spring Lake	US 401 Bypass	Gardner St			15		3									
44916.3.139	Cumberland	Fay. / Spring Lake	US 401 Bypass	Lady Cheryl Dr			10		2									
44916.3.140	Cumberland	Fay. / Spring Lake	US 401 Bypass	Lady Viola Dr			10		2									
44916.3.141	Cumberland	Fay. / Spring Lake	US 401 Bypass	SR 1007 (All American Fwy)			10		2									
44916.3.142	Cumberland	Fay. / Spring Lake	US 401 Bypass	SR 1404 (Morganton Rd)			20					4						
<b>TOTAL FOR WBS NO. 44916.3.12</b>					<b>0.5</b>	<b>10</b>	<b>4,071</b>	<b>350</b>	<b>250</b>	<b>40</b>	<b>0</b>	<b>545</b>	<b>1</b>	<b>1</b>	<b>0</b>	<b>25</b>	<b>25</b>	
44916.3.13	Harnett	Lillington	US 421 (W Front St)	8th St.	0.5	10	5		3			1	1	1		25	25	Subject to Historic/Cultural Review. May be Deleted from Contract.
44916.3.13	Harnett	Lillington	US 421 (W Front St)	9th St.			10		2			2						Subject to Historic/Cultural Review. May be Deleted from Contract.
44916.3.13	Harnett	Lillington	US 421 (W Front St)	10th St.			10	61	1			2						Subject to Historic/Cultural Review. May be Deleted from Contract.
44916.3.13	Harnett	Lillington	US 421 (W Front St)	11th St.			10			2								
44916.3.13	Harnett	Lillington	US 421 (W Front St)	13th St.				276										
44916.3.13	Harnett	Lillington	400 / 210 / 27 (S Main St)	1208 Driveway							7							
44916.3.13	Harnett	Lillington	401 / 210 / 27 (S Main St)	KidzCare Driveway			10			2								
44916.3.13	Harnett	Lillington	401 / 210 / 27 (S Main St)	E Northington St.			10		1			2						
44916.3.13	Harnett	Lillington	401 / 210 / 27 (S Main St)	NC 27					1									
44916.3.13	Harnett	Lillington	401 / 210 / 27 (S Main St)	E Washington St			10	58		2								
44916.3.13	Harnett	Lillington	401 / 210 / 27 (S Main St)	E McNeill St.			10	8				2			1			* Adjustment of MH not DI
44916.3.13	Harnett	Lillington	401 / 210 / 27 (S Main St)	Lofton St.			20					4						
44916.3.13	Harnett	Lillington	401 / 210 / 27 (S Main St)	Killigrey St.			10		2			2						
44916.3.13	Harnett	Lillington	401 / 210 / 27 (S Main St)	James St.			20					4						Subject to Historic/Cultural Review. May be Deleted from Contract.
44916.3.13	Harnett	Lillington	401 / 210 / 27 (S Main St)	Ivey St.			20					4						Subject to Historic/Cultural Review. May be Deleted from Contract.
44916.3.13	Harnett	Lillington	401 / 210 / 27 (S Main St)	Front St.			10	132		2								Subject to Historic/Cultural Review. May be Deleted from Contract.

PROJECT	COUNTY	MUNICIPALITY	MAJOR ROUTE	MINOR ROUTE	0000100000-N Mobilization	1220000000-E Incidental Stone Base	2549000000-E 2'-6" Concrete Curb & Gutter	2591000000-E 4" Concrete Sidewalk (5' Wide)	2600000000-N Retrofit Existing Curb Ramp	2605000000-N Concrete Curb Ramp	2612000000-E 6" Concrete Driveway	2613000000-N Remove & Replace Curb Ramps	2800000000-N Adjustments of Catch Basins	2815000000-N Adjustments of Drop Inlets	2830000000-N Adjustment of Manholes	4695000000-E Thermoplastic Pavement Marking Lines (8", 90 mils)	4891000000-E Thermoplastic Pavement Marking Lines (24", 90 mils)	NOTES	
44916.3.13	Harnett	Lillington	401 / 210 / 27 (S Main St)	Harnett St			10			1		1						Subject to Historic/Cultural Review. May be Deleted from Contract. Site may require additional work items for Retaining Wall. May be Field Adjusted, as needed.	
44916.3.13	Harnett	Lillington	Various Locations					115										Spot Replacement of S/W	
<b>SUBTOTAL</b>					<b>0.5</b>	<b>10</b>	<b>165</b>	<b>650</b>	<b>10</b>	<b>9</b>	<b>7</b>	<b>24</b>	<b>1</b>	<b>1</b>	<b>1</b>	<b>25</b>	<b>25</b>		
44916.3.13	Harnett	Angier	NC 210 (E Depot St)	BB&T Driveway			5			1		1							
44916.3.13	Harnett	Angier	NC 210 (E Depot St)	Dunn St			10					2							
44916.3.13	Harnett	Angier	NC 210 (E Depot St)	Willow St			135	80											
44916.3.13	Harnett	Angier	NC 55 (N Raleigh St)	Smithfield St			10												
44916.3.13	Harnett	Angier	NC 55 (N Raleigh St)	Stuart's, Tea Tyme, Pineda			10	129		2	20								
44916.3.13	Harnett	Angier	NC 55 (N Raleigh St)	Hardee's			30	118		6									
44916.3.13	Harnett	Angier	NC 55 (N Raleigh St)	Carlie C's IGA				293											
44916.3.13	Harnett	Angier	NC 55 (N Raleigh St)	First Bank			5	73		1									
44916.3.13	Harnett	Angier	NC 55 (N Raleigh St)	Cutts St					2										
44916.3.13	Harnett	Angier	NC 55 (N Raleigh St)	E Williams St					2										
44916.3.13	Harnett	Angier	SR 1500 (Mclver St)	Broad St					2										
<b>SUBTOTAL</b>					<b>0.0</b>	<b>0</b>	<b>205</b>	<b>693</b>	<b>6</b>	<b>10</b>	<b>20</b>	<b>3</b>	<b>0</b>	<b>0</b>	<b>0</b>	<b>0</b>	<b>0</b>		
44916.3.13	Harnett	Coats	SR 1700 (E Main Street)	Ida St			5	34	2	1	27	2						Subject to Historic/Cultural Review. May be Deleted from Contract.	
44916.3.13	Harnett	Coats	SR 1700 (E Main Street)	Railroad St			15			3		2						Subject to Historic/Cultural Review. May be Deleted from Contract.	
44916.3.13	Harnett	Coats	NC 55 (S. McKinley St.)	W. Parrish St.			10	10				2							
<b>SUBTOTAL</b>					<b>0.0</b>	<b>0</b>	<b>30</b>	<b>44</b>	<b>2</b>	<b>4</b>	<b>27</b>	<b>6</b>	<b>0</b>	<b>0</b>	<b>0</b>	<b>0</b>	<b>0</b>		
44916.3.13	Harnett	Erwin	NC 217 ( N. 13th St.)	Erwin Plant LLC			5	5				1							
44916.3.13	Harnett	Erwin	NC 217 ( N. 13th St.)	E. I St.			5	5				1							
44916.3.13	Harnett	Erwin	NC 217 ( S. 13th St.)	E. F St.			15	15				3						Subject to Historic/Cultural Review. May be Deleted from Contract.	
<b>SUBTOTAL</b>					<b>0.0</b>	<b>0</b>	<b>25</b>	<b>25</b>	<b>0</b>	<b>0</b>	<b>0</b>	<b>5</b>	<b>0</b>	<b>0</b>	<b>0</b>	<b>0</b>	<b>0</b>	<b>0</b>	
<b>SUBTOTAL FOR WBS NO. 44916.3.13 - HARNETT COUNTY</b>					<b>0.5</b>	<b>10</b>	<b>425</b>	<b>1412</b>	<b>18</b>	<b>23</b>	<b>54</b>	<b>38</b>	<b>1</b>	<b>1</b>	<b>1</b>	<b>25</b>	<b>25</b>		
44916.3.13	Cumberland	Stedman	NC 24 (Clinton Rd.)	Hillsboro St.			10	10				2							
44916.3.13	Cumberland	Stedman	NC 24 (Clinton Rd.)	E. First St.			10	10				2							
44916.3.13	Cumberland	Stedman	NC 24 (Clinton Rd.)	Circle Dr			5			1									
<b>SUBTOTAL</b>					<b>0.0</b>	<b>0</b>	<b>25</b>	<b>20</b>	<b>0</b>	<b>1</b>	<b>0</b>	<b>4</b>	<b>0</b>	<b>0</b>	<b>0</b>	<b>0</b>	<b>0</b>	<b>0</b>	
<b>SUBTOTAL FOR WBS NO. 44916.3.13 - CUMBERLAND COUNTY</b>					<b>0.0</b>	<b>0</b>	<b>25</b>	<b>20</b>	<b>0</b>	<b>1</b>	<b>0</b>	<b>4</b>	<b>0</b>	<b>0</b>	<b>0</b>	<b>0</b>	<b>0</b>	<b>0</b>	
<b>TOTAL FOR WBS NO. 44916.3.13</b>					<b>0.5</b>	<b>10</b>	<b>450</b>	<b>1432</b>	<b>18</b>	<b>24</b>	<b>54</b>	<b>42</b>	<b>1</b>	<b>1</b>	<b>1</b>	<b>25</b>	<b>25</b>		
<b>GRAND TOTAL</b>					<b>1.0</b>	<b>20</b>	<b>4,521</b>	<b>1,782</b>	<b>268</b>	<b>64</b>	<b>54</b>	<b>587</b>	<b>2</b>	<b>2</b>	<b>1</b>	<b>50</b>	<b>50</b>		